

TRACK CATALOG

	PAGE(S)
Running Track Surfaces.....	2
Running Track Rubber Curbing	3-5
Running Track Aluminum Curbing & Roll Out Runway	6
Multiple Lane Dry Line Chalker / Marking Chalk	7
Running Track Protective Covers	8-13
Hurdles	14-17
Starting Blocks	18-20
Long Jump Pit Surfaces	21-22
Long Jump Pit Covers	23-24
Take-Offs & Toe Boards.....	25
High Jump.....	26-32
Pole Vault	33-40
Shot Put Throwing Sector Surfaces.....	41
Shots Throwing Weights Hammers	38, 42-43
Stands, Wagons, Rakes	44
Officiating.....	45
Discus Cage, Rings, Sector Guide, Tape	46-47



YOUR " ONE-STOP " SOURCE FOR AMERICA'S BASEBALL, SOFTBALL & SPORTS SURFACES & SUPPLIES!

PRICES SUBJECT TO CHANGE & AVAILABILITY PLUS SHIPPING | VOLUME DISCOUNTS AVAILABLE | COOPERATIVE PURCHASING CONTRACT PRICING FOR 50 STATES

PARTAC PEAT CORPORATION
ONE KELSEY PARK, GREAT MEADOWS, NEW JERSEY 07838

800-247-BEAM (2326) • (908) 637-4191 • FAX (908) 637-8421
www.beamclay.com • sales@beamclay.com
Bid Term - 5/9/18 - 5/8/20; Extended to 5/8/21; Extended to 5/8/22

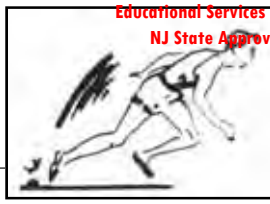

BEAM CLAY®

Running Track Surfaces

WHOLESALE PRICE LIST: F.O.B. GREAT MEADOWS, NJ
EFFECTIVE: JANUARY 1, 2021

JET TRACK™ RUNNING TRACKS

Economical Alternatives to Synthetic, All-Weather Tracks for New Running Tracks or for Many Years Of Higher Performance from Your Existing Cinder Track!

Jet Track Mixes, which can be applied over your present cinder track, are quality controlled mixes, with natural clay or Stabilizer® Binder blended with 3/16" crushed aggregate, superior to coal cinders as they will not break down and become powdery.

Jet Track Mix makes a firm, smooth surface with great drainage. Available in burgundy red, grey, black, white or tan, with either 20% red, grey, black, white or tan **Beam Clay® Binder** for a smoother surface, or 5% red, grey, black, white or tan **Beam Clay® Binder** for a somewhat "crunchier" surface, or "**STABILIZED**" in red, grey, black, white or tan for a firmer, yet more resilient, surface – each with excellent drainage and resistance to erosion. Excellent natural surfaces for walking paths & jogging trails. Easy to maintain: Recommended maintenance is to scarify and roll each spring. Otherwise, drag mat as needed to maintain smooth surface. Recommended depth for a new track is 3"; for resurfacing a cinder track 1-3". Resurfacing a cinder track can be tapered with 3" on inside lanes out to 1" in outer lanes.

Stabilizer® binds the aggregate together for a firm, yet more resilient, natural running track surface requiring minimal maintenance.

3/16" Red, Grey, Black, White or Tan Jet Track™ with Natural Beam Clay® Binder

One cubic yard weighs approximately 2,700 lbs. in red, approximately 3,240 lbs. in grey, black white or tan, plus add 20% for compaction. Each 1" compacted requires approximately 5 tons per 1,000 square feet for red, 6 tons for grey, black, white or tan. Each 1" compacted over a 400 meter x 32' wide running track with starting area will require approximately 248 tons for red, 298 tons for grey, black, white or tan.

		BULK/TON		50 LB. BAG Up to 50/pallet
Burgundy Red with 5% Beam Clay® Red Binder	JT-R5 BULK	\$60	JT-R5 BAG	\$6.50
Burgundy Red with 20% Beam Clay® Red Binder	JT-R20 BULK	\$90	JT-R20-BAG	\$7.25
Grey, Black or White with 5% Beam Clay® Grey Binder	JT-(G,B,W)5-BULK	\$60	JT-(G,B,W)5 BAG	\$6.75
Grey, Black or White with 20% Beam Clay® Grey Binder	JT-(G,B,W)20-BULK	\$90	JT-(G,B,W)20 BAG	\$7.50
Tan with 5% Beam Clay® Tan Binder	JT-T5 BULK	\$80	JT-T5 BAG	\$8
Tan with 20% Beam Clay® Tan Binder	JT-T20 BULK	\$110	JT-T20 BAG	\$8.75

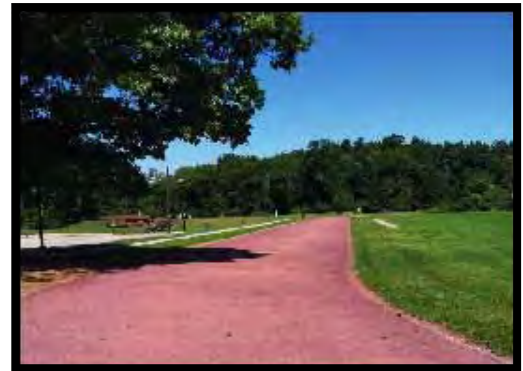

3/16" Red, Grey, Black, White or Tan Stabilized Jet Track™ with Stabilizer® Binder

For an even firmer yet more resilient surface with even less maintenance: 3/16" crushed aggregate blended with Stabilizer® at the rate of 15 lbs. per ton of aggregate. One cubic yard weighs approximately 2,700 lbs. in red, approximately 3,240 lbs. in grey, black, white or tan plus add 20% for compaction. Each 1" compacted requires approximately 5 tons per 1,000 square feet for red, 6 tons for grey, black, white or tan. Each 1" compacted over a 400 meter x 32' wide running track with starting area will require approximately 248 tons for red, 298 tons for grey, black, white or tan.

		BULK/TON		50 LB. BAG Up to 50/pallet
Burgundy Red with Stabilizer® Binder	JT-RS BULK	\$115	JT-RS BAG	\$8
Grey, Black or White with Stabilizer® Binder	JT-(G,B,W)S BULK	\$115	JT-(G,B,W)S BAG	\$8.25
Tan with Stabilizer® Binder	JT-TS BULK	\$135	JT-TS BAG	\$9.50

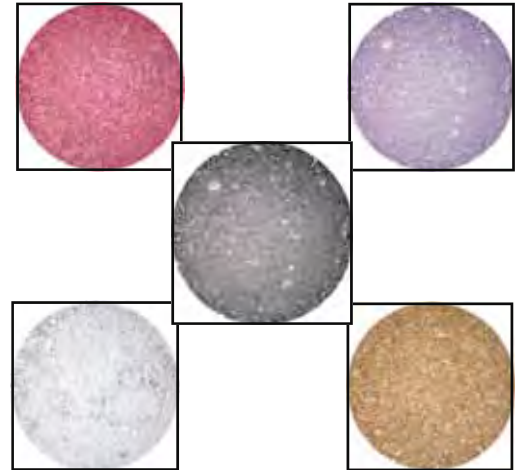

We have other track surfaces without **BEAM CLAY®** binder or **STABILIZER®** binder. While these will not give the level of performance as the above for running tracks, they do provide excellent surfaces for walking or jogging tracks:

Regional CRUSHED RED STONE TRACK MIXES, RED BRICK TRACK, and RED LAVA TRACK from plants in the East, South, MidWest, and West Coast.

PALLET & COVER CHARGES: \$6.50/PALLET. #NJ-PALLET

YOUR "ONE-STOP" SOURCE FOR AMERICA'S BASEBALL, SOFTBALL & SPORTS SURFACES & SUPPLIES!

PRICES SUBJECT TO CHANGE & AVAILABILITY PLUS SHIPPING | VOLUME DISCOUNTS AVAILABLE | COOPERATIVE PURCHASING CONTRACT PRICING FOR 50 STATES

PARTAC PEAT CORPORATION
ONE KELSEY PARK, GREAT MEADOWS, NEW JERSEY 07838

800-247-BEAM (2326) • (908) 637-4191 • FAX (908) 637-8421
www.beamclay.com • sales@beamclay.com
Bid Term - 5/9/18 - 5/8/20; Extended to 5/8/21; Extended to 5/8/22

BEAM CLAY®

Running Track Rubber Curbing

WHOLESALE PRICE LIST
 EFFECTIVE: JULY 1, 2021

RUNNING TRACK RUBBER CURBING

PER PIECE

4" High x 4" Wide x 6' Long (30 lbs./piece, up to 99 pieces/pallet)	#RC-4X4X6	\$35
6" High x 4" Wide x 6' Long (45 lbs./piece, up to 63 pieces/pallet)	#RC-6X4X6	\$65
8" High x 4" Wide x 6' Long (70 lbs./piece, up to 45 pieces/pallet)	#RC-8X4X6	\$82
4" High x 3" Wide x 6' Long (20 lbs./piece, up to 100 pieces/pallet)	#RC-4X3X6	\$36
4" High x 3" Wide x 4' Long (13 lbs./piece, up to 140 pieces/pallet)	#RC-4X3X4	\$20

*Please note: The 4" wide sections are grooved and can be stacked to create desired height. However, the 3" W is not stackable. 3" W lengths of curbing are **not grooved for stacking**.*

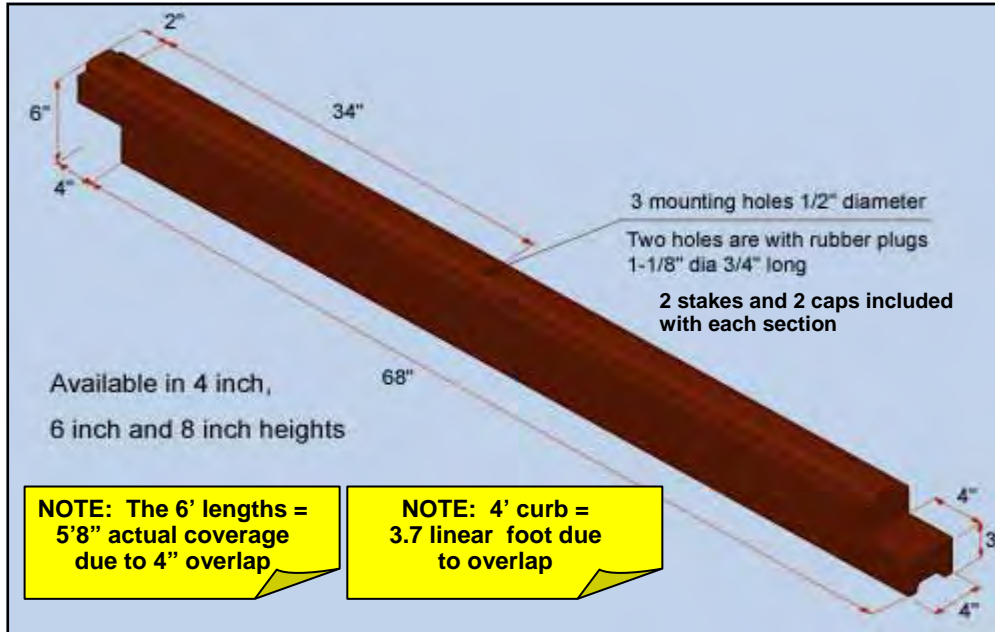

- \$ More resilient than wood
- \$ No warping or discoloring
- \$ No splinters
- \$ Non toxic
- \$ Will not rot
- \$ Stackable
- \$ Interlocking
- \$ Available in 4 ft lengths and 4" High or 6 ft lengths in 4", 6" and 8" heights
- \$ No CCA or other harmful chemicals
- \$ Easy to install with pre drilled holes
- \$ Made from 100% recycled tires
- \$ Flexible with rounded edges
- \$ Will not breed ticks, termites or other insects
- \$ Maintenance free
- \$ Hardware & Caps included
- \$ Neutral brown tone-compatible with any surface color

2 stakes and 2 caps are included with each curb

natural brown bendable stackable interlocking hardware included

YOUR "ONE-STOP" SOURCE FOR AMERICA'S BASEBALL, SOFTBALL & SPORTS SURFACES & SUPPLIES!

PRICES SUBJECT TO CHANGE & AVAILABILITY PLUS SHIPPING | VOLUME DISCOUNTS AVAILABLE | COOPERATIVE PURCHASING CONTRACT PRICING FOR 50 STATES

BEAM CLAY®

Running Tracks - Installing Rubber Curbing

RUNNING TRACKS - INSTALLING RUBBER CURBING



YOUR " ONE-STOP" SOURCE FOR AMERICA'S BASEBALL, SOFTBALL & SPORTS SURFACES & SUPPLIES!

PRICES SUBJECT TO CHANGE & AVAILABILITY PLUS SHIPPING | VOLUME DISCOUNTS AVAILABLE | COOPERATIVE PURCHASING CONTRACT PRICING FOR 50 STATES

PARTAC PEAT CORPORATION
ONE KELSEY PARK, GREAT MEADOWS, NEW JERSEY 07838

800-247-BEAM (2326) • (908) 637-4191 • FAX (908) 637-8421
www.beamclay.com • sales@beamclay.com
Bid Term - 5/9/18 - 5/8/20; Extended to 5/8/21; Extended to 5/8/22

BEAM CLAY®

Running Tracks - Rubber Curbing Specification

**Rubber Curbing
For Running Tracks****Product Specifications****Product Description:**

1. Material: compression molded composite of the 100% recycled rubber and polyurethane prepolymer
2. Physical properties of the rubber composite:
 - a) Density 0.6 oz/cu in (ASTM C642)
 - b) Durometer Hardness 65A \pm 7 (ASTM D2240)
 - c) Tensile Strength* minimum 125 psi (ASTM D412)
(* main structural areas)
 - d) Compression deformation 10% at 70psi, 68°F (ASTM D575)
 - e) Brittleness at Low temperature: -40°F (ASTM D746)
 - f) Freeze and thaw when exposed (ASTM C672)
to deicing chemicals no loss after 50 cycles
 - g) Coefficient of thermal expansion: 8×10^{-5} in/in/°F (ASTM C531)
 - h) Weathering 70 hours at 158°F (ASTM D573)
 - hardness retained 100% (\pm 5%)
 - compressive strength 100% (\pm 5%)
 - tensile strength 100% (\pm 5%)
 - elongation retained 100% (\pm 5%)
3. Available models:
 - a) 4"W x 4"H x 72"L with weight of 30 lbs.
 - b) 4"W x 6"H x 72"L with weight of 45 lbs.
 - c) 4"W x 8"H x 72"L with weight of 70 lbs.
 - d) 3"W x 4"H x 72"L with weight of 20 lbs.
 - e) 3"W x 4"H x 48"L with weight of 13 lbs.
4. Finishing color: dark brown

Installation methods:

- a) with 2 spikes 18" long x 3/8" diameter provided for each 4" high piece
- b) with 2 spikes 24" long x 3/8" diameter provided for each 6" high or 8" high piece

Note: The mounting holes can be closed after installation with the rubber plugs 1-1/8 diameter and 3/4" long, supplied with the product.

Components:

- a) 100% recycled rubber from car and truck tires (NR, SBR)
- b) polyurethane prepolymer for rubber granules
- c) brown pigment

YOUR "ONE-STOP" SOURCE FOR AMERICA'S BASEBALL, SOFTBALL & SPORTS SURFACES & SUPPLIES!

PRICES SUBJECT TO CHANGE & AVAILABILITY PLUS SHIPPING | VOLUME DISCOUNTS AVAILABLE | COOPERATIVE PURCHASING CONTRACT PRICING FOR 50 STATES

BEAM CLAY®

WHOLESALE PRICE LIST EFFECTIVE: JULY 1, 2021

Outdoor Track Aluminum Curbing

All Weather Track Aluminum Curbing

Aluminum track curbing is designed to save tremendous amounts of labor on installation, last for decades and provide continual functionality. Accurate measurements on-site or drawings required.

- \$ Structural aluminum tubing is pre-bent to reduce stress on track surface
- \$ Installation only requires from 12 to 24 holes in your track surface, while other systems require literally hundreds of holes to be drilled to keep curb sections in place under tension
- \$ Interlocking joints between 20' sections are precision machined for a snug fit requiring no hardware connectors - allows expansion and contraction for stability under all conditions
- \$ Welded aluminum drain pads raise curb 1/2" off the track surface and allow water and debris to run off freely
- \$ Mill finish is standard or upgrade to the silver anodized finish for extra durability



Aluminum Curbing	#3AC	\$17.25/LF
Silver Anodized Option	#3AC-SA	\$22/LF



Running Track Aluminum Curbing

- \$ Outdoor track curbing composed of structural aluminum 2" x 5" tubing. Pre-bent to proper radius in 20' sections.
- \$ Designed to anchor to poured concrete monuments
- \$ Also can be used as shot-put area border

Aluminum Curbing	#5AC	\$24/LF
------------------	-------------	----------------

Roll Out Runway

- \$ Made to be rolled over existing worn out runways.
- \$ Use as a protective surface on all-weather track during football games or other activities.
- \$ Made with a black rubber/urethane mix.
- \$ 10mm (3/8") thick.
- \$ Custom lengths are available.
- \$ Minimum order 50'.
- \$ 12mm available - call for pricing

32" wide (per linear ft)	TR32	\$12/LF
36" wide (per linear ft)	TR36	\$12.50/LF
42" wide (per linear ft)	TR42	\$13/LF
48" wide (per linear ft)	TR48	\$14/LF



YOUR "ONE-STOP" SOURCE FOR AMERICA'S BASEBALL, SOFTBALL & SPORTS SURFACES & SUPPLIES!

PRICES SUBJECT TO CHANGE & AVAILABILITY PLUS SHIPPING | VOLUME DISCOUNTS AVAILABLE | COOPERATIVE PURCHASING CONTRACT PRICING FOR 50 STATES

BEAM CLAY®

Line Marking Equipment—Dry

WHOLESALE PRICE LIST
 EFFECTIVE: JANUARY 1, 2021



Multiple Lane Dry Chalk Track Marker

Makes preparation for a meet a quick job! Two people can lay out a track in 30 minutes. Works on any track. When a curb is present every line will be uniformly accurate to the fraction of an inch. Set-up time for use or storage is five minutes. Each hopper can hold up to 25 lbs. and go 440 yards. Hoppers do not have a shut off, it's free flowing once it starts moving, just adjust speed to obtain desired thickness.

LMLD-440-8	7 hopper 8 lane; '440 yd. capacity; class 65; 192 lbs.	\$3,395
LMLD-440-7	6 hopper 7 lane; '440 yd. capacity; class 65; 177 lbs.	\$3,050
LMLD-440-6	5 hopper 6 lane; '440 yd. capacity; class 65; 162 lbs.	\$2,695
LMLD-440-5	4 hopper 5 lane; '440 yd. capacity; class 65; 147 lbs.	\$2,350
LMLD-440-4	3 hopper 4 lane; '440 yd. capacity; class 65; 132 lbs.	\$1,995
LMLD-440-EXT	replacement hopper; '440 yd. capacity; UPS 15 lbs.	\$350
LMLD-MAIN	replacement main assembly, 87 lbs.	\$995

For full line of Athletic Field Marking Chalk see:
 107A - Field Marking Chalk and Dry Line Marking Equipment

YOUR "ONE-STOP" SOURCE FOR AMERICA'S BASEBALL, SOFTBALL & SPORTS SURFACES & SUPPLIES!

PRICES SUBJECT TO CHANGE & AVAILABILITY PLUS SHIPPING | VOLUME DISCOUNTS AVAILABLE | COOPERATIVE PURCHASING CONTRACT PRICING FOR 50 STATES

BEAM CLAY®

WHOLESALE PRICE LIST
 EFFECTIVE: JULY 1, 2021

Weighted Track Protectors

BLANKET STYLE WEIGHTED TRACK PROTECTORS

TAKES THE BEATING IN HIGH-TRAFFIC AREAS! Let Track Protectors take the beating in high-traffic areas, so your track can stay smooth. Standard or Crossover sizing.



Blanket Style Track Protector Specifications

Fabric	Non-woven polypropylene 15 oz/sy
Top Surface	Heat tempered, retains durability, even from cleats
Bottom Surface	Heat tempered - loose fibers won't cling to track
Blanket Color	Heather gray to reflect heat
Binding Color	18 oz. Solid Vinyl available in 14 colors, see chart
Binding	Hemmed, weighted vinyl lies flat and stays in place



<u>15 OZ. SIZE</u>	<u>ITEM #</u>	<u>EACH</u>
7' x 30'	WTP-BS-7X30	\$540
7' x 40'	WTP-BS-7X40	\$645
7' x 50'	WTP-BS-7X50	\$760
14' x 30'	WTP-BS-14X30	\$730
14' x 40'	WTP-BS-14X40	\$865
14' x 50'	WTP-BS-14X50	\$1,075
14' x 75'	WTP-BS-14X75	\$1,450
14' x 100**	WTP-BS-14X100	\$1,840
14' x 125**	WTP-BS-14X125	\$2,260
14' x 150**	WTP-BS-14X150	\$2,575

CUSTOM SIZE **WTP-BS-CUSTOM** Call for quote.

*Easier handling if made in two sections with Velcro attachment.

Printing not available on blanket-style protectors.

18 oz. Solid Vinyl Hem Colors (actual colors may vary)



YOUR "ONE-STOP" SOURCE FOR AMERICA'S BASEBALL, SOFTBALL & SPORTS SURFACES & SUPPLIES!

PRICES SUBJECT TO CHANGE & AVAILABILITY PLUS SHIPPING | VOLUME DISCOUNTS AVAILABLE | COOPERATIVE PURCHASING CONTRACT PRICING FOR 50 STATES

PARTAC PEAT CORPORATION
 ONE KELSEY PARK, GREAT MEADOWS, NEW JERSEY 07838

800-247-BEAM (2326) • (908) 637-4191 • FAX (908) 637-8421
 www.beamclay.com • sales@beamclay.com
 Bid Term - 5/9/18 - 5/8/20; Extended to 5/8/21; Extended to 5/8/22

BEAM CLAY®

WHOLESALE PRICE LIST EFFECTIVE: JULY 1, 2021

Armor Mesh Weighted Track Protectors

ARMOR MESH WEIGHTED TRACK PROTECTORS

TAKES THE BEATING IN HIGH-TRAFFIC AREAS! Let Track Protectors take the beating in high-traffic areas, so your track can stay smooth. Standard or Crossover sizing.

ARMOR MESH TRACK PROTECTORS SPECIFICATIONS

- \$ Heavy-duty 14 OZ. vinyl coated woven polyester
- \$ Retains durability even from cleats, and allows water to drain
- \$ Available in 13 colors

14 OZ. SIZE	ITEM #	EACH
6' x 30'	AM-WTP-6X30	\$430
6' x 40'	AM-WTP-6X40	\$520
6' x 50'	AM-WTP-6X50	\$590
12' x 30'	AM-WTP-12X30	\$565
12' x 40'	AM-WTP-12X40	\$750
12' x 50'	AM-WTP-12X50	\$920
15' x 30'	AM-WTP-15X30	\$705
15' x 40'	AM-WTP-15X40	\$925
15' x 50'	AM-WTP-15X50	\$1,160
15' x 75'	AM-WTP-15X75	\$1,655
15' x 100'	AM-WTP-15X100	\$2,135
30' x 50'	AM-WTP-30X50	\$2,010
Custom < 300	AM-WTP-C<300	\$2.39/SF
Custom > 300	AM-WTP-C>300	\$2.18/SF

Please note: Armor Mesh Weighted Track Protectors are manufactured without solid vinyl edging. If solid vinyl edging is required add 10%.

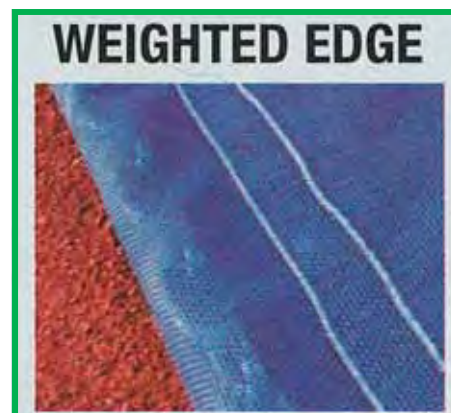

LETTERING/ONE OR MULTI-COLORED

42" H	LTRS/#42C	\$70
48" H	LTRS/#48C	\$81
54" H	LTRS/#54C	\$94
60" H	LTRS/#60C	\$108
Minimum	LTRS/#MINC	\$275



CUSTOM LOGOS/ONE OR MULTI-COLORED

Up to 15 SF (ex. 3' x 5')	LOGOS-C-15SF	\$295
Up to 30 SF (ex. 5' x 6')	LOGOS-C-30SF	\$375
Up to 50 SF (ex. 5' x 10')	LOGOS-C-50SF	\$565
Up to 100 SF (ex. 10' x 10')	LOGOS-C-100SF	\$995

YOUR "ONE-STOP" SOURCE FOR AMERICA'S BASEBALL, SOFTBALL & SPORTS SURFACES & SUPPLIES!

PRICES SUBJECT TO CHANGE & AVAILABILITY PLUS SHIPPING | VOLUME DISCOUNTS AVAILABLE | COOPERATIVE PURCHASING CONTRACT PRICING FOR 50 STATES

BENCH ZONE® SIDELINE TRACK PROTECTOR

WIND WEIGHTED TRACK PROTECTOR

RESISTS & CUSHIONS AGAINST CLEATS, BUT RAIN DRAINS THROUGH.

These track protectors resist and cushion against cleats, shoes, and wheeled equipment ... yet allow water to drain through. Made of tough polypropylene geotextile fabric with vinyl edging with steel chain inserted all around for ballast. This keeps Protector down even in high winds without stakes. To reduce weight for easier installation, longer Sideline models have sections that join with hook-and-loop strips. Tarp body is black. Standard edging is choice of white or gold. Also available: 15 other colors of the 18 oz. vinyl edging.



BZST1575	15' x 75'	284 lbs.	\$1,250
BZST15100	15' x 100' ^{**}	352 lbs.	\$1,535
BZST15125	15' x 125' ^{**}	420 lbs.	\$1,895
BZST15150	15' x 150' ^{**}	488 lbs.	\$2,250
BZSTX	CUSTOM SIZES, OVER 801 SF		\$1.25/SF

**** UNITS ARE IN TWO PIECES THAT JOIN AT CENTERLINE WITH VELCRO® FASTENING**

18 OZ. VINYL COLOR CHART

White	Grey	Beige/Tan	Black	Maroon	Red	Orange	Yellow/Gold	
Kelly Green	Midnight Green	Medium Green	Navy	Royal Blue	CC Sky Blue	Purple	Vegas Gold	Sport Grey/Charcoal

ACTUAL COLOR OF MATERIALS MAY VARY FROM EACH "LOT" / "RUN".

IF YOU ARE TRYING TO MATCH A SPECIFIC COLOR, PLEASE REQUEST A SAMPLE FROM THE CURRENT STOCK AVAILABLE FOR PRODUCTION.

YOUR "ONE-STOP" SOURCE FOR AMERICA'S BASEBALL, SOFTBALL & SPORTS SURFACES & SUPPLIES!

PRICES SUBJECT TO CHANGE & AVAILABILITY PLUS SHIPPING | VOLUME DISCOUNTS AVAILABLE | COOPERATIVE PURCHASING CONTRACT PRICING FOR 50 STATES

BEAM CLAY®

Running Tracks—Weighted Track Protectors

WHOLESALE PRICE LIST
EFFECTIVE: JULY 1, 2021

BENCH ZONE #3 TRACK PROTECTORS

Third Generation (3G) for Unmatched Durability, Color Choice and Imprinting

3G infuses a durable three-dimensional continuous nylon filament (Enka Mat) with our **VIPOL®** Matrix Mesh providing better cushion that **WON'T STICK TO THE TRACK**. It's **NEXT LEVEL** in all-surface protection! Add Chroma-Bond multi-color imprinting to proudly display school colors, ID and LOGO.

<ul style="list-style-type: none"> \$ Does Not Retain Water \$ Is Mold and Mildew Resistant \$ Less Expensive Than Our 2G Track Protector! \$ Includes Ballasted Chain Ends Only for Easier Portability \$ Available in 23 Different Colors with 17 Vinyl Border Color Options \$ Add Chroma-Bond® Imprinting with Team Lettering, Logos, and Advertising \$ CUSTOM Sizes, Manufactured in Standard 6' and 12' Widths 	<ul style="list-style-type: none"> 3GCO630 6' X 30' 3GCO640 6' X 40' 3GCO650 6' X 50' 3GCO1230 12' X 30' 3GCO1240 12' X 40' 3GCO1250 12' X 50' 2GCOX CUSTOM SIZES up to 800 SF 2GBZSTX CUSTOM SIZES over 800 SF 	<ul style="list-style-type: none"> \$550/EA \$725/EA \$865/EA \$975/EA \$1,250/EA \$1,525/EA \$4.25/SF \$2.95/SF
--	---	--

See page 26 for CHROMA-BOND Imprinting



18 OZ. VINYL COLOR CHART

White	Grey	Beige/Tan	Black	Maroon	Red	Orange	Yellow/Gold	
Kelly Green	Midnight Green	Medium Green	Navy	Royal Blue	CC Sky Blue	Purple	Vegas Gold	Sport Grey/Charcoal

ACTUAL COLOR OF MATERIALS MAY VARY FROM EACH "LOT" / "RUN".
IF YOU ARE TRYING TO MATCH A SPECIFIC COLOR, PLEASE REQUEST A SAMPLE FROM THE CURRENT STOCK AVAILABLE FOR PRODUCTION.

VIPOL® MATRIX COLOR CHART

White	Grey	Beige/Tan	Brown	Black	Maroon	Scarlet	Red	Burnt Orange	Orange	Vegas Gold	
Gold	Yellow	Aqua	Kelly Green	Forest Green	Midnight Green	Navy	ProBlue	Royal Blue	CC Sky Blue	Purple	Sport Grey/Charcoal

ACTUAL COLOR OF MATERIALS MAY VARY FROM EACH "LOT" / "RUN".
IF YOU ARE TRYING TO MATCH A SPECIFIC COLOR, PLEASE REQUEST A SAMPLE FROM THE CURRENT STOCK AVAILABLE FOR PRODUCTION.

YOUR "ONE-STOP" SOURCE FOR AMERICA'S BASEBALL, SOFTBALL & SPORTS SURFACES & SUPPLIES!

PRICES SUBJECT TO CHANGE & AVAILABILITY PLUS SHIPPING | VOLUME DISCOUNTS AVAILABLE | COOPERATIVE PURCHASING CONTRACT PRICING FOR 50 STATES

BEAM CLAY®

Running Tracks—Weighted Track Protectors

WHOLESALE PRICE LIST
EFFECTIVE: JULY 1, 2021

CROSS-OVER ZONE® TRACK PROTECTORS

PROTECTS COSTLY TRACK SURFACE

These track protectors resist and cushion against cleats, shoes, and wheeled equipment ... yet allow water to drain through. Made of tough polypropylene geotextile fabric with vinyl edging with steel chain inserted all around for ballast. This keeps Protector down even in high winds without stakes. To reduce weight for easier installation, longer Sideline models have sections that join with hook-and-loop strips. Tarp body is black. Standard edging is choice of white or gold. Also available: 15 other colors of the 18 oz. vinyl edging.



CO1530	15' x 30'	90 lbs.	\$665/EA
CO1540	15' x 40'	113 lbs.	\$810/EA
CO1550	15' x 50'	136 lbs.	\$985/EA
CO7530	7.5' x 30'	66 lbs.	\$465/EA
CO7540	7.5' x 40'	84 lbs.	\$565/EA
CO7550	7.5' x 50'	104 lbs.	\$685/EA
COX	CUSTOM SIZES, UP TO 800 SF		\$2.25/SF
18 oz. Vinyl Border , colors other than White or Gold TPVB-C			N/C



CROSS-OVER ZONE 3G TRACK PROTECTORS

Third Generation (3G) for Unmatched Durability,
Color Choice and Imprinting

Third Generation (3G) infuses a durable three-dimensional continuous nylon filament (Enka Mat) with our VIPOL® Matrix Mesh providing better cushion that WON'T STICK TO THE TRACK. It's NEXT LEVEL in all-surface protection! Add Chroma-Bond multi-color imprinting to proudly display school colors, ID and LOGO.

3GBZST1275	12 X 75	\$1,965/EA	3GCO630	6' X 30'	\$550/EA
3GBZST12100	12 X 100	\$2,495/EA	3GCO640	6' X 40'	\$710/EA
3GBZST12125	12 X 125	\$2,985/EA	3GCO650	6' X 50'	\$865/EA
3GBZST12150	12 X 150	\$3,495/EA	3GCO1230	12' X 30'	\$975/EA
3GBZSTX	CUSTOM SIZES greater than 801+ SF	\$2.95/SF	3GCO1240	12' X 40'	\$1,255/EA
			3GCO1250	12' X 50'	\$1,525/EA
			3GCOX	CUSTOM SIZES up to 800 SF	\$4.25/SF
			3GBZSTX	CUSTOM SIZES over 800 SF	\$2.95/SF

See page 13 for CHROMA-BOND Imprinting

See page 11 for VIPOL & Vinyl Color Options

YOUR "ONE-STOP" SOURCE FOR AMERICA'S BASEBALL, SOFTBALL & SPORTS SURFACES & SUPPLIES!

PRICES SUBJECT TO CHANGE & AVAILABILITY PLUS SHIPPING | VOLUME DISCOUNTS AVAILABLE | COOPERATIVE PURCHASING CONTRACT PRICING FOR 50 STATES

BEAM CLAY®

Chroma Bond Imprinting

WHOLESALE PRICE LIST
EFFECTIVE: JULY 1, 2021

CHROMA-BOND IMPRINTING

Chroma-Bond Imprinting, 1 Color Logo Only

1COL25SF	Up to 25SF	\$550/EA
1COL2650SF	26SF—50SF	\$725/EA
1COL51100SF	51SF-100SF	\$995/EA

Chroma-Bond Imprinting, 2 Color Logo Only

2COL25SF	Up to 25SF	\$675/EA
2COL2650SF	26SF—50SF	\$850/EA
2COL51100SF	51SF-100SF	\$1,150/EA

Chroma-Bond Imprinting, 3 Color Logo Only

3COL25SF	Up to 25SF	\$760/EA
3COL2650SF	26SF—50SF	\$925/EA
3COL51100SF	51SF-100SF	\$1,215/EA

1 Color		Chroma-Bond Imprinting Letters or Numbers	2 Color	
1COL24	\$56/EA.	Up to 24" Tall	2COL24	\$76/EA
1COL36	\$68/EA	36" Tall	2COL36	\$88/EA
1COL48	\$84/EA	48" Tall	2COL48	\$104/EA
1COL60	\$98/EA	60" Tall	2COL60	\$118/EA
1COL72	\$120/EA	72" Tall	2COL72	\$139/EA
1COL84	\$131/EA	84" Tall	2COL84	\$151/EA
1COL96	\$150/EA	96" Tall	2COL96	\$171/EA
1COL108	\$178/EA	108" Tall	2COL108	\$198/EA
1COL120	\$206/EA	120" Tall	2COL120	\$226/EA



Our sharp multi-color images will outlast other processes. Eliminates the historic problems of digital printing, like weathering, premature fading, scuffing, and unsightly white mesh backside color. Images will last outdoors as long as the fabric, something rarely true with digital imprinting. Also highly spike, cleat, and racquet resistant. Our thick, individually-applied, double coating process literally bonds the image into the vinyl and completely masks the underlying fabric color, so image colors are vivid and true.

Chroma-Bond imprinting is available on our vinyl-surfaced windscreen, cover, padding & sign products.



YOUR "ONE-STOP" SOURCE FOR AMERICA'S BASEBALL, SOFTBALL & SPORTS SURFACES & SUPPLIES!

PRICES SUBJECT TO CHANGE & AVAILABILITY PLUS SHIPPING | VOLUME DISCOUNTS AVAILABLE | COOPERATIVE PURCHASING CONTRACT PRICING FOR 50 STATES

PARTAC PEAT CORPORATION
ONE KELSEY PARK, GREAT MEADOWS, NEW JERSEY 07838

800-247-BEAM (2326) • (908) 637-4191 • FAX (908) 637-8421
www.beamclay.com • sales@beamclay.com
Bid Term - 5/9/18 - 5/8/20; Extended to 5/8/21; Extended to 5/8/22

STACKHOUSE HURDLES

ORDER 80+ HURDLES:
Get free freight (48 states), school name on boards and risers in school colors.



Riser Color Choices



A. Cantabrian Aluminum "INTERNATIONAL" Hurdle

- \$ Designed for College and International competition.
- \$ 2 1/2" by 2" extruded aluminum ribbed profile base with beveled edges make for sleek, stable, safe and easy stack design.
- \$ Spring loaded weights weight easily adjusts to correct pullover weight for all 5 heights.
- \$ Spring loaded riser. Adjust to 30", 33", 36", 39" & 42" height.
- \$ Poly board is double ribbed and uses UV inhibitors to help insure long board life.

TICH-ADJC F Class 92.5, 29 lbs **\$245**

B. Elite Aluminum H.S. Hurdle

- \$ Open face constructed base.
- \$ Welded one-piece aluminum base.
- \$ Grooved bases for interlocking stacking.
- \$ 5-height adjustments, 30", 33", 36", 39", & 42".
- \$ Meets NFHS rules.

TEHS F Class 92.5, 23 lbs **\$195**

C. Elite Aluminum College Hurdle

- \$ Internal sliding weight makes hurdle legal pull over weight at all College heights.
- \$ Open face constructed base.
- \$ Welded one-piece aluminum base.
- \$ Grooved interlocking bases stabilize hurdle in transport.
- \$ 5 height adjustments: 30", 33", 36", 39" & 42"

TECH F Class 92.5 25 lbs **\$215**

D. Regal "L" Hurdle

- \$ Stackhouse's #1 selling Middle School and High School hurdle.
- \$ Meets all NFHS standards.
- \$ All Steel Construction.
- \$ Weighted to meet official turn over specifications.
- \$ Adjusts to 30", 33", 36", 39", & 42".
- \$ Silver zinc plated base & gold zinc plated risers.
- \$ 41" PVC gate board with spring-loaded risers.
- \$ Shipping discounts available for quantity.

TRLH F Class 92.5, 28 lbs **\$130**

YOUR "ONE-STOP" SOURCE FOR AMERICA'S BASEBALL, SOFTBALL & SPORTS SURFACES & SUPPLIES!

PRICES SUBJECT TO CHANGE & AVAILABILITY PLUS SHIPPING | VOLUME DISCOUNTS AVAILABLE | COOPERATIVE PURCHASING CONTRACT PRICING FOR 50 STATES

BEAM CLAY®

Stackhouse Hurdles

WHOLESALE PRICE LIST
EFFECTIVE: JANUARY 1, 2021

STACKHOUSE HURDLES

ORDER 80+ HURDLES:
Get free freight (48 states), school name on boards and risers in school colors.



A. Aluminum H.S. Rocker Hurdle

- \$ 5-height adjustments: 30", 33", 36", 39", 42".
- \$ Lightweight aluminum construction.
- \$ Self-adjusting weight system.
- \$ Meets pull-over requirements at all heights.
- \$ Powder coated risers provide smooth non-rigid snag free surface.
- \$ Nylock nuts attach PVC gate to riser and provide superior holding power and rigidity.
- \$ Meets all NFHS standards and pull over weights.
- \$ Shipping discounts available for quantity.

TARH F Class 92.5, 31 lbs **\$135**
(3 or less ship UPS Dimensional)

B. Cantabrian Aluminum High School Open Face hurdle

- \$ 5 height adjustments: 30", 33", 36", 39" & 42"
- \$ Welded base construction for superior strength.
- \$ 1 1/4" O.D. Aluminum tubing.
- \$ Open face approach, no rear.
- \$ No assembly necessary "ready to use".
- \$ Meets all NFHS pull over weights.
- \$ Spring loaded buttons for easy height adjustment.
- \$ Shipping discounts available in quantity.
- \$ Stackable.

TCOFH F Class 92.5, 21 lbs **\$169**

C. Aluminum One-Piece High School Rocker Hurdle

- \$ Aluminum, one-piece base eliminates bolts that can loosen
- \$ 5-height adjustments: 30", 33", 36", 39", 42"
- \$ Meets all H.S. pullover specifications for all heights and all High School federation rules.

THAER F Class 92.5, 21 lbs **\$115**

D. Junior Elementary Hurdle (1st through 6th Grades)

- Excellent for beginners and advanced training.
- \$ Sturdy steel construction.
- \$ Risers powder coated blue.
- \$ Gate height adjusts 21" - 24" - 27" & 30".
- \$ 36" wide PVC gate board.
- \$ Shipping discounts available for quantity.

TJEH F 15 lbs. Ships Dimensional **\$105**



YOUR "ONE-STOP" SOURCE FOR AMERICA'S BASEBALL, SOFTBALL & SPORTS SURFACES & SUPPLIES!

PRICES SUBJECT TO CHANGE & AVAILABILITY PLUS SHIPPING | VOLUME DISCOUNTS AVAILABLE | COOPERATIVE PURCHASING CONTRACT PRICING FOR 50 STATES

TSI / OLYMPIA HURDLES



OLYMPIA ALUMINUM SUPER HURDLE

Professional grade, all-aluminum hurdle with a square profile base and round uprights. Meets NFHS, NCAA & IAAF specifications. Constructed with strong ribbed PVC hurdle board. Easy-glide hurdle features a weight adjust system. Stainless steel nuts and bolts and powder-coated sliding weights ensure ultimate weather protection for years of hassle-free usage. Bright colored height and weight indicator stickers. Height range 27" to 42".

HOAS

SHIPS BY TRUCK

\$265



OLYMPIA ALUMINUM COMPETITION HURDLE

Professional grade, all-aluminum hurdle with a square profile base and round uprights. Meets NFHS, NCAA & IAAF specifications. Constructed with strong ribbed PVC hurdle board. Easy-glide hurdle features a weight adjust system. Stainless steel nuts and bolts and powder-coated sliding weights ensure ultimate weather protection for years of hassle-free usage. Bright colored height and weight indicator stickers. Height range 27" to 42".

HOAC

SHIPS BY TRUCK

\$250



CLUB ROCKER HURDLE

The Trigon Sports Club Rocker hurdle is ideal for high school competition. Made of a strong steel frame, this hurdle features a push-button locking device to quickly adjust to your hurdling height. Comes with PVC Bar. L-shaped base controls rocker action, while sealed weights control resistance. Dual tube base ensures structural strength and easy stacking. Adjustable height range from 36" to 42".

HROCK

SHIPS BY TRUCK

\$115



ADJUSTABLE TRAINING HURDLE

- \$ Adjusts to 11 different sizes from 9"-42"
- \$ High-impact plastic crossboard
- \$ Powder-coated 1"D steel legs
- \$ Ideal for polymetrics, speed & agility
- \$ Great for beginners to use
- \$ Hurdle folds flat for easy transport & storage

HATH

SHIPS BY TRUCK

\$50

YOUR "ONE-STOP" SOURCE FOR AMERICA'S BASEBALL, SOFTBALL & SPORTS SURFACES & SUPPLIES!

PRICES SUBJECT TO CHANGE & AVAILABILITY PLUS SHIPPING | VOLUME DISCOUNTS AVAILABLE | COOPERATIVE PURCHASING CONTRACT PRICING FOR 50 STATES

BEAM CLAY®

Hurdle Carts / Field Wagons

WHOLESALE PRICE LIST
 EFFECTIVE: JANUARY 1, 2021

Hurdle Carts / Field Wagons



Hanging Hurdle Cart

This 6 wheel cart with its heavy-duty all steel construction carries 8-14 hurdles at a time, depending on brand/model. Center wheels are slightly lowered for easy rotating. Unique design helps transport hurdles over curbs and through rough grass or loose gravel with no problems. This cart will accommodate both college and high school hurdles.

THHC

F Class 70, 121 lbs

\$649

2 Wheel Hurdle Cart

Place hurdles in a stack, slide hurdle cart underneath, tilt hurdles back on 2 pneumatic wheels. Steel construction. Holds 8 -10 hurdles.

TH2WD

UPS 35 lbs

\$485



Super Field Wagon

Same features as TFW510. Constructed of tread-plate, rust free aluminum surface and frame.

TFFAC510

1000 lb. capacity. 5' x 10'
 F Class 100, 234 lbs

\$2,295

TFFAC48

1000 lb. capacity. 4' x 8'
 F Class 100, 178 lbs

\$1,795

Field Wagon

Transport all pits, hurdles, standards, and more! Industrial grade front axle swivel provides ease in steering. Heavy-duty plywood floor recessed in steel frame. 16" fully pneumatic tires. Can be used behind a small tractor.

TFFW510

1000 lb. capacity. 5' x 10'
 F Class 100, 275 lbs

\$1,895



Cantabrian Flight Hurdle Cart

4 wheel design. Swivel wheels at back for easy steering. Holds up to 10 hurdles. Steel construction. Black powder coat finish. College

THFC

UPS 35 lbs

\$295

Adjustable Height Training Hurdle

Great tool for plyometric and hurdling exercises. Adjusts from 6"- 42". Frame is made of durable steel tube and uses plastic crossbar for a long lasting, easy to use training aid. Folds easy for storage and inexpensive UPS shipping.

TAJDH

UPS 8 lbs

\$45

YOUR "ONE-STOP" SOURCE FOR AMERICA'S BASEBALL, SOFTBALL & SPORTS SURFACES & SUPPLIES!

PRICES SUBJECT TO CHANGE & AVAILABILITY PLUS SHIPPING | VOLUME DISCOUNTS AVAILABLE | COOPERATIVE PURCHASING CONTRACT PRICING FOR 50 STATES

BEAM CLAY®

WHOLESALE PRICE LIST
EFFECTIVE: JANUARY 1, 2021

Starting Blocks

Starting Blocks

A. Championship Starting Block

- \$ 5" wide 4-position adjustable pedals.
- \$ 2.5" center rail.
- \$ Lightweight aluminum construction.
- \$ Fitting High School and College competition.
- \$ All-weather spikes included.

TCHAMP UPS 11 lbs

\$130

B. Cheetah Elite Aluminum Starting Block

- \$ 5" wide 4-position adjustable pedals.
- \$ 3" center rail.
- \$ Lightweight aluminum construction.
- \$ Fitting Collegiate and International competition.
- \$ All-weather spikes included.

TCEB UPS 16 lbs

\$185

C. Olympia Adjustable Starting Block

- \$ 4" wide adjustment pedals.
- \$ Pedal adjusts to virtually ANY angle!
- \$ Snap lock plunger locks pedals into position quickly.
- \$ Includes all-weather and anchor spikes with adjustment wrench.

TOLY UPS 12 lbs

\$75

D. Speed Star Starting Block

- \$ Adjustment pins are spring loaded so pedals can be quickly moved.
- \$ Includes all-weather spikes.

TSTAR UPS 11 lbs

\$75

E. Indoor Starting Blocks (pair)

- \$ Red rubber blocks (color may vary).
- \$ Adhere to any clean floor without glue.
- \$ NO holes in floor.
- \$ Removes easily from floor surface.

TISB UPS 9 lbs

\$32

F. Heavy Duty Starting Block Cart

- \$ Holds up to 12 blocks.
- \$ Large rubber tires for an easy roll.
- \$ User-friendly extended handle.
- \$ Metal tray for extra storage.

TSBC2 UPS 79 lbs

\$849

G. Starting Block Cart

- \$ Holds 12 starting blocks.
- \$ 3" swivel rubber wheel casters.
- \$ Steel construction.
- \$ Large base tray for storage.

TSECON UPS 58 lbs

\$285

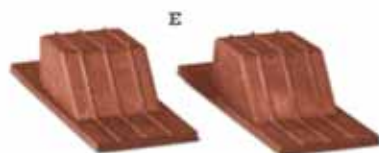
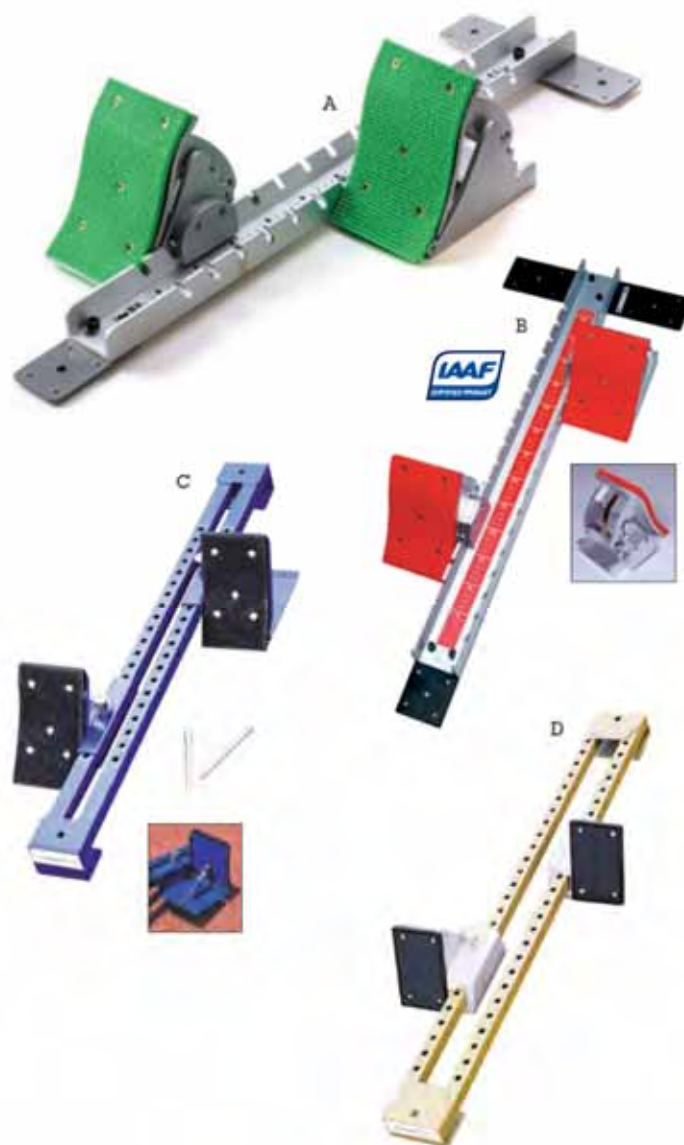

YOUR "ONE-STOP" SOURCE FOR AMERICA'S BASEBALL, SOFTBALL & SPORTS SURFACES & SUPPLIES!

PRICES SUBJECT TO CHANGE & AVAILABILITY PLUS SHIPPING | VOLUME DISCOUNTS AVAILABLE | COOPERATIVE PURCHASING CONTRACT PRICING FOR 50 STATES

BEAM CLAY®

WHOLESALE PRICE LIST EFFECTIVE: JANUARY 1, 2021

Starting Blocks

Starting Blocks

H. Cantabrian Gran Prix Starting Block

Pursue your passion with ultimate quality. Eight inch square five angle pedal face. Customize with 35, 45, 55, 60, or 65 degree angle. Angle makes a big difference how you come out of the block. You come out running. You're not working. Your torso is carrying you. You get a better push off. Proper shin angles and flex response. Your hips and torso are higher. Perfect block to develop, refine, and improve your technique, strength, and speed. Take advantage of your training. Push thru the post. Drive off the block with your power leg.

- \$ Easy Carry center handle.
- \$ Pedals will not come off block in transit.
- \$ Easy to change threaded spike inserts.
- \$ Ideal for International and Collegiate competition.
- \$ Meets NFHS regulations and is IAAF certified. [hide]

College/ Elite High Schools
TCGP UPS 16 lbs

\$425



I. Cantabrian Catapult Starting block

- \$ Forged aluminum pedals. 11" x 6" pedals. Adjust to 5 angles - 35, 45, 55, 60 & 65 degree settings. Black powder coated attractive finish. Wedged side plates lock into rail.
- \$ Sleek designed center rail. 3 1/4" wide. 3/8" extruded aluminum. Easy lock adjustment notches. Infinite adjustment locations. Scale down center rail. Easy space and visual adjustment. Carry handle for moving and storage.
- \$ Black powder coated end plates. Tapped to take regular track shoe spike size. Usable on any surface.

TCCAT UPS 13 lbs

\$285

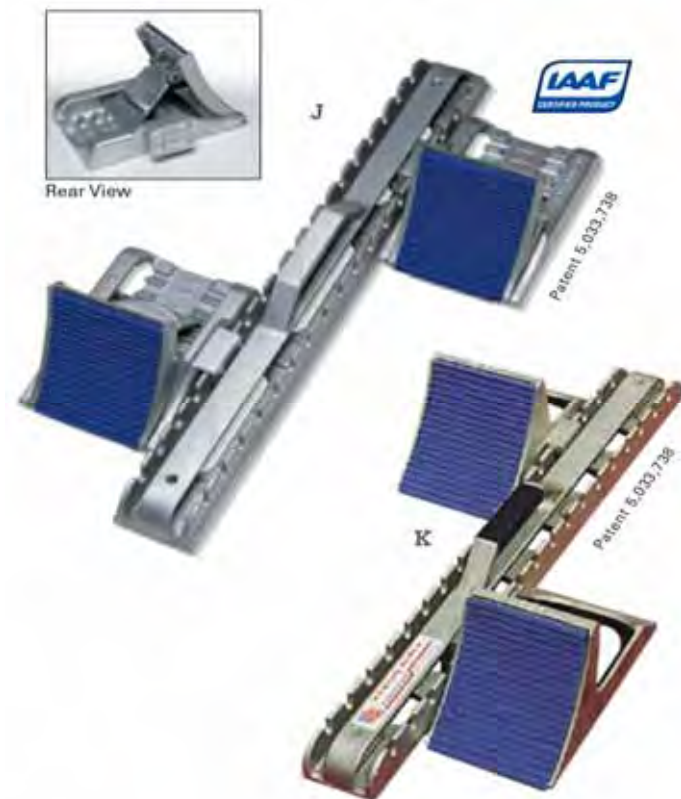
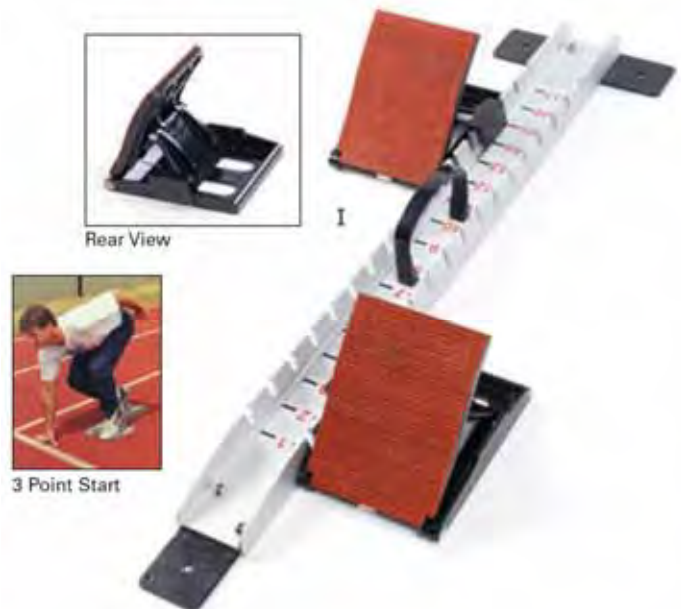

J. Newton International "BEST" "The Real Thing!"

- \$ Highest quality Collegiate and International starting system.
- \$ High quality light-weight all Aluminum casting.
- \$ 5 pedal angle adjustments 35°, 45°, 55°, 60° and 65°.
- \$ Easy carry center rail.
- \$ Pedals will not come off rail during transport.
- \$ Pedals have threaded spike inserts - "easy changes outs".
- \$ Includes threaded spikes for synthetic surface.

T1008 UPS 14 lbs

\$385

K. Newton Elite "Better"

- \$ High quality light-weight all Aluminum casting.
- \$ Easy carry center rail.
- \$ Pedals will not come off rail during transport.
- \$ Pedals have threaded spike inserts - "easy change outs!".

T1007 UPS 13 lbs

\$245

YOUR "ONE-STOP" SOURCE FOR AMERICA'S BASEBALL, SOFTBALL & SPORTS SURFACES & SUPPLIES!

PRICES SUBJECT TO CHANGE & AVAILABILITY PLUS SHIPPING | VOLUME DISCOUNTS AVAILABLE | COOPERATIVE PURCHASING CONTRACT PRICING FOR 50 STATES

Starting Blocks

OLYMPIC PRO STARTING BLOCK

The Olympic Block is a super heavy-duty block especially designed for professional athletes. All aluminum block with center rail 4" wide x 35" long and slotted angles to firmly grip pedals. Adjustable at four different angles. All pedals fitted with special thick rubber to take in spikes. Suitable block for synthetic track. Comes with steel plates. Flushed to center rail. Meets NFHS, NCAA & IAAF specifications.

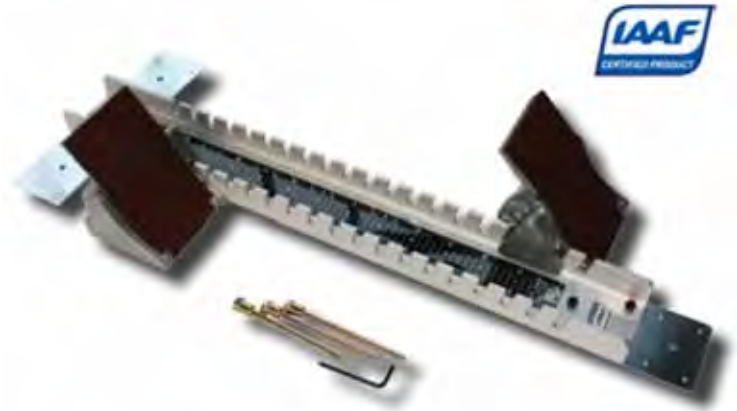
SBPRO**\$265**

OLYMPIC STADIUM STARTING BLOCK

Another version of our Olympic block with light aluminum pedals and 3" aluminum center rail. Detachable and adjustable aluminum pedals. Meets NFHS, NCAA & IAAF specifications.

SBSTAD**\$215**

OLYMPIC ELITE ALUMINUM STARTING BLOCK

An economy Olympic block for high school competition. Features a 2.5" aluminum center rail and aluminum pedals. Detachable and adjustable aluminum pedals. Meets NFHS, NCAA & IAAF specifications.

SBELITE**\$145**

YOUR "ONE-STOP" SOURCE FOR AMERICA'S BASEBALL, SOFTBALL & SPORTS SURFACES & SUPPLIES!

PRICES SUBJECT TO CHANGE & AVAILABILITY PLUS SHIPPING | VOLUME DISCOUNTS AVAILABLE | COOPERATIVE PURCHASING CONTRACT PRICING FOR 50 STATES

BEAM CLAY®

Long Jump Pit Surfaces

LONG JUMP PIT SURFACES



YOUR " ONE-STOP " SOURCE FOR AMERICA'S BASEBALL, SOFTBALL & SPORTS SURFACES & SUPPLIES!

PRICES SUBJECT TO CHANGE & AVAILABILITY PLUS SHIPPING | VOLUME DISCOUNTS AVAILABLE | COOPERATIVE PURCHASING CONTRACT PRICING FOR 50 STATES

PARTAC PEAT CORPORATION
ONE KELSEY PARK, GREAT MEADOWS, NEW JERSEY 07838

800-247-BEAM (2326) • (908) 637-4191 • FAX (908) 637-8421
www.beamclay.com • sales@beamclay.com
Bid Term - 5/9/18 - 5/8/20; Extended to 5/8/21; Extended to 5/8/22

BEAM CLAY®

WHOLESALE PRICE LIST EFFECTIVE: JANUARY 1, 2021

Long Jump Pit Surfaces

LONG JUMP PIT SANDS	Washed, Screened Silica Sands.	TO GET APPROX PRICE/CU. YD. MULTIPLY BY 1.2	BULK PER TON		PER 50 LB. BAG
White / Medium	Approximately 85% between .25mm - 1.0mm				
South Jersey Plant		WM-SJBU	\$25		—
North Jersey Plant		WM-NJBU	\$45		—
White / Medium—Double Screened	Approximately 85% between .25mm - 1.0mm				
North Jersey Plant		WM-DS-NJBU	\$48	WM-DS-NJBAG	\$5.25
White / Medium / Heat-Treated	Approximately 85% between .25mm - 1.0mm				
North Jersey Plant		WM-HT-NJBU	\$69	WM-HT-NJBAG	\$5.50
White / Fine					
South Jersey Plant		WF-SJBU	\$55		—
White / Very Fine	Approximately 90% between .15mm - .4mm				
South Jersey Plant		WVF-SJBU	\$25		—
Extra-White / Fine	Approximately 75% between .25mm - 1.0mm				
North Jersey Plant			—	XWF-NJBAG	\$5.50
White / Extra-Fine	Approximately 75% between .25mm - 1.0mm				
South Jersey Plant		WEF-SJBU	\$27		—
White / Medium-Fine					
South Jersey Plant		WMF-SJBU	\$27		—
White / Medium-Coarse					
South Jersey Plant		WMC-SJBU	\$29		—
Bright White Crushed Marble / Medium-Coarse	.25mm - 1.0mm				PER 3,000 LB/ BULK BAG
MA Plant		SW-MC-MABU	\$50		
White / Heat Treated - 30/50**	Approximately 95% between .25mm—1mm, 100% passing 2mm)				
South Jersey Plant		WHT3050-SJBU	\$88	WHT3050-SJBB	\$300
White / Heat Treated - 20/40**	Approximately 98% between .25mm—1mm, predominantly .5—1mm, 100% passing 2mm)				
South Jersey Plant		WHT2040-SJBU	\$90	WHT2040-SJBB	\$310
White / Heat Treated - 16/30**	Approximately 98% between .25mm—1mm, predominantly .25—1mm, 100% passing 2mm)				
South Jersey Plant		WHT1630-SJBU	\$100	WHT1630-SJBB	\$415
White / Heat Treated - 18/60*	slightly broader range than 30/50 Approximately 90% between .25mm—1mm, predominantly .5—1mm, 100% passing 2mm)				
South Jersey Plant		WHT1860-SJBU	\$70	WHT1860-SJBB	\$198
White / Heat Treated - 18/100*	Approximately 85% between .25mm—1mm, predominantly .25—1mm, 100% passing 2mm)				
South Jersey Plant		WHT18100-SJBU	\$65	WHT18100-SJBB	\$175
White / Heat Treated - 35/70*	Approximately 85% between .25mm—1mm, predominantly .25—.5mm, 100% passing 2mm)				
South Jersey Plant		WHT3570-SJBU	\$70	WHT3570-SJBB	\$190
White / Heat Treated - 35/100*	Approximately 85% between .25mm—1mm, predominantly .25—.5mm, 100% passing 2mm)				
South Jersey Plant		WHT35100-SJBU	\$50	WHT35100-SJBB	\$170
White / Heat Treated - 40/100**	Approximately 70% between .25mm—1mm, predominantly .25—.5mm, 100% passing 2mm)				
South Jersey Plant		WHT40100-SJBU	\$88	WHT40100-SJBB	\$335

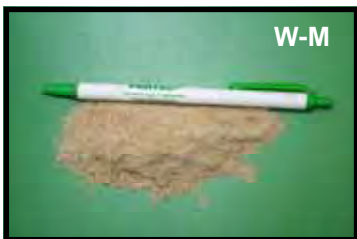

* Minimum Order: 1 Pallet

** Minimum Order: 11 Tons in Bulk or 4 Pallets of Bulk Bags

PALLET & COVER CHARGES: \$6.50/PALLET. #NJ-PALLET

YOUR "ONE-STOP" SOURCE FOR AMERICA'S BASEBALL, SOFTBALL & SPORTS SURFACES & SUPPLIES!

PRICES SUBJECT TO CHANGE & AVAILABILITY PLUS SHIPPING | VOLUME DISCOUNTS AVAILABLE | COOPERATIVE PURCHASING CONTRACT PRICING FOR 50 STATES

BEAM CLAY®

Weighted Long Jump Pit Covers

WHOLESALE PRICE LIST
EFFECTIVE: JULY 1, 2021

LANDING ZONE™ BALLASTED PIT COVERS

KEEPS SAND IN and KIDS AND ANIMALS OUT!

Made with our exclusive Vipol® Matrix Mesh Material, the Landing Zone™ Ballasted Pit Covers are tough beyond belief. Your sand stays where it belongs, in the pit, protected from wind, animals, and children. But rain, sun, and air penetrate the material, eliminating water pooling and mold. Also available in reinforced solid vinyl.



Galvanized steel chain is installed in the edge hem all around, providing enough ballast to keep wind from getting under. These covers **STAY PUT IN HIGH WINDS** without stakes or sandbags.

LZXVIPOL LZ Ballasted Pit Cover made with 10 oz. Vipol™ Matrix Mesh—Available in 23 colors!

\$2.95/sq.ft.

LZXVINYL LZ Ballasted Pit Cover made with 18 oz. Solid Vinyl—Available in 17 colors!

\$2.90/sq.ft.

CHROMA-BOND imprinting available see page 15

Sizes: All Landing Zone™ Ballasted Pit Covers are CUSTOM sized.

VIPOL® MATRIX COLOR CHART

White	Grey	Beige/Tan	Brown	Black	Maroon	Scarlet	Red	Burnt Orange	Orange	Vegas Gold	
Gold	Yellow	Aqua	Kelly Green	Forest Green	Midnight Green	Navy	ProBlue	Royal Blue	CC Sky Blue	Purple	Sport Grey/ Charcoal

18 OZ. VINYL COLOR CHART

White	Grey	Beige/Tan	Black	Maroon	Red	Orange	Yellow/Gold	
Kelly Green	Midnight Green	Medium Green	Navy	Royal Blue	CC Sky Blue	Purple	Vegas Gold	Sport Grey/Charcoal

ACTUAL COLOR OF MATERIALS MAY VARY FROM EACH "LOT" / "RUN".
IF YOU ARE TRYING TO MATCH A SPECIFIC COLOR, PLEASE REQUEST A SAMPLE FROM THE CURRENT STOCK AVAILABLE FOR PRODUCTION.

YOUR "ONE-STOP" SOURCE FOR AMERICA'S BASEBALL, SOFTBALL & SPORTS SURFACES & SUPPLIES!

PRICES SUBJECT TO CHANGE & AVAILABILITY PLUS SHIPPING | VOLUME DISCOUNTS AVAILABLE | COOPERATIVE PURCHASING CONTRACT PRICING FOR 50 STATES

BEAM CLAY®

WHOLESALE PRICE LIST EFFECTIVE: JULY 1, 2021

Weighted Long Jump Pit Covers

WEIGHTED LONG JUMP PIT COVERS

SAVE THE COST OF MAINTAINING JUMP PITS!

Features

- Weighted around perimeter – requires no sandbags or stakes
- Available with either steel ball bearings or steel chain in heat-sealed hem all around perimeter.
- Available in standard sizes or custom.
- Printable 18 oz. or 14 oz.



18 oz. Solid

14 oz. ArmorMesh



Fabrics	18 oz. Solid Vinyl	14 oz. ArmorMesh	6 oz. Polyethylene
Properties	Waterproof 14 colors	Heavy-duty allows for water penetration and keeps out debris. 13 colors	Waterproof Light weight Silver/White



WARRANTY
Weighted Long Jump Pit Covers:
Solid Vinyl & ArmorMesh—
3 year warranty.
Polyethylene—2 year warranty

18 oz. Solid Vinyl With Heat-Sealed Hem

Standard Sizes

12' x 28'	WWLJPC18OZ12X28	\$600
12' x 30'	WWLJPC18OZ12X30	\$640
12' x 32'	WWLJPC18OZ12X32	\$675
12' x 34'	WWLJPC18OZ12X34	\$710

Custom Size WWLJPC18OZC \$2.08/SF

14 oz. Premium ArmorMesh With Heat-Sealed Hem

Standard Sizes

12' x 28'	WWLJPCAM12X28	\$525
12' x 30'	WWLJPCAM12X30	\$565
12' x 32'	WWLJPCAM12X32	\$590
12' x 34'	WWLJPCAM12X34	\$630

Custom Size WWLJPCAMC \$1.88/SF

6 oz. Solid Silver/White Polyethylene with Sewn Hem

Standard Sizes

12' x 28'	WWLJPC6OZ12X28	\$385
12' x 30'	WWLJPC6OZ12X30	\$410
12' x 32'	WWLJPC6OZ12X32	\$425
12' x 34'	WWLJPC6OZ12X34	\$435

Custom Size WWLJPC6OZC \$1.31/SF

WEIGHTED EDGE



STANDARD FEATURE



Weighted edge on ArmorMesh

LETTERING ONE OR MULTI-COLORED

42" H	LTRS/#42C	\$70
48" H	LTRS/#48C	\$81
54" H	LTRS/#54C	\$94
60" H	LTRS/#60C	\$108
Minimum	LTRS/#MINC	\$275

OPTIONAL PRINTING



CUSTOM LOGOS/ ONE OR MULTI-COLORED

Up to 15 SF (ex. 3' x 5')	LOGOS-C-15SF	\$275
Up to 30 SF (ex. 5' x 6')	LOGOS-C-30SF	\$375
Up to 50 SF (ex. 5' x 10')	LOGOS-C-50SF	\$535
Up to 100 sf (ex. 10' x 10')	LOGOS-C-100SF	\$965

YOUR "ONE-STOP" SOURCE FOR AMERICA'S BASEBALL, SOFTBALL & SPORTS SURFACES & SUPPLIES!

PRICES SUBJECT TO CHANGE & AVAILABILITY PLUS SHIPPING | VOLUME DISCOUNTS AVAILABLE | COOPERATIVE PURCHASING CONTRACT PRICING FOR 50 STATES

BEAM CLAY®

WHOLESALE PRICE LIST EFFECTIVE: JANUARY 1, 2021

Take-Off & Toe Boards

TAKE-OFF & TOE BOARDS



Tray System

This 8" wide tray system is the most popular tray system for both the college and high school market. The 8" wide board meets all the specifications for college and high school. The weatherproof high-density urethane top surface of the board makes an excellent take off surface. The take-off board is mounted to a steel framework with 6 adjusting bolts so that you can level the board with the runway surface. The heavy-duty tray is made of bright zinc plated steel.

TTSS UPS 75 lbs

\$625



side view

Poly High School Take-Off Board

New problem solving technology poly take-off board eliminates durability and cracking problems often experienced in wood boards. Long lasting poly surface comes with a 5-year warranty. This two part poly board has a softer texture 3/4" top board for better plants. Attached to high density 3/4" grey poly under board to eliminate warping.

TPOLYTB UPS 48 lbs

\$315



Tray for TPOLYTB

For permanent installation in synthetic runways, this 48" x 20" stainless steel tray system works with our TPOLYTB take-off board. Drain holes for all weather conditions.

THSTBT UPS 36 lbs

\$439



A

B



International Take-Off Tray System

Made the same as our TTSS board with the addition of a foul board and cover. Foul board is made of 1/2" plywood and can easily be taken out and plasticine put in for meets. Cover is made of heavy-duty steel.

TTICS UPS 105 LBS

\$1,275

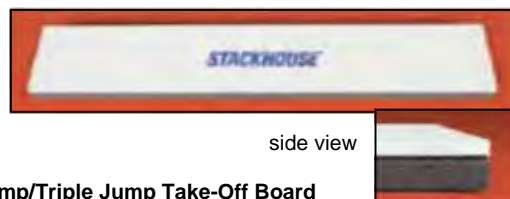

side view

Long Jump/Triple Jump Take-Off Board

This official take-off board is made with the same technology as our TPOLYTB board. 48" long by 8" wide. 3/4" polyurethane top surface on 1 1/2" x 8" plastic underboard.

TLT Ups 24 LBS

\$229



Counter sunk for bolt & washer.

Recessed for ring

Poly Toe Board

Our Poly Toe Board is designed with Linear Low-Density Polyethylene (LLDPE) and UV stabilizer for maximum durability. This design eliminates the potential for rusting, common in metal boards, and its solid construction prevents chipping and cracking often seen with wood or fiberglass boards.

TPTB Ups 15 LBS

\$349

A. Cast Aluminum Toe Board

Cast aluminum construction, meets all rule specifications. Designed for level pads.

TATB For level pad (most common), UPS 24 lbs
TATB-DP Depressed pad, UPS 24 lbs

\$525
\$525



B. All Metal Shot Toe Board

Cannot warp, split, or deteriorate in weather. Radiating lines speed up accurate measurement.

TMTB UPS 25 lbs

\$239

YOUR "ONE-STOP" SOURCE FOR AMERICA'S BASEBALL, SOFTBALL & SPORTS SURFACES & SUPPLIES!

PRICES SUBJECT TO CHANGE & AVAILABILITY PLUS SHIPPING | VOLUME DISCOUNTS AVAILABLE | COOPERATIVE PURCHASING CONTRACT PRICING FOR 50 STATES

BEAM CLAY®

Stackhouse | Cantabrian High Jump Pit Value Packs

WHOLESALE PRICE LIST
EFFECTIVE: JANUARY 1, 2021

High Jump Value Packages



Elementary High Jump

Elementary School High Jump Value Package

- Includes:
- 1-TH612 Elementary high jump pit.
 - 1-TH612A Elementary high jump pit all weather cover.
 - 1-TBS pair budget high jump standards.
 - 1-TFG13-1 13' 1 1/2" fiberglass crossbar.
 - 13 YEAR WARRANTY

TVPEHJ F Class 250, 189 lbs

CALL FOR PRICE



H.S. High Jump

H.S. High Jump Value Package

- Includes:
- 1-TH816 Challenger high jump pit.
 - 1-TH816A Challenger high jump pit all weather cover.
 - 1-TRSS pair steel roll away high jump standards.
 - 1-TFG13-1 13' 1 1/2" fiberglass crossbar.
 - 13 YEAR WARRANTY

TVPHHJ F Class 250, 389 lbs

CALL FOR PRICE



International High Jump

H.S. Cut-out High Jump Value Package

- Includes:
- 1-THC1016 Challenger cut-out high jump pit.
 - 1-THC1016A Challenger high jump pit all weather cover.
 - 1-TRSS pair steel roll away high jump standards.
 - 1-TFG13-1 13' 1 1/2" fiberglass crossbar.
 - 13 YEAR WARRANTY

TVPOHJ F Class 250, 445 lbs

CALL FOR PRICE

International High Jump Value Package by Cantabrian

- Includes:
- 1-THCO1018 International high jump pit.
 - 1-THCO1018A International high jump pit all weather cover.
 - 1-TRASC pair aluminum roll away high jump standards.
 - 1-TFG13-1 13' 1 1/2" fiberglass crossbar.
 - 13 YEAR WARRANTY

TVPCHJ F Class 250, 450 lbs

CALL FOR PRICE

H.S. Pole Vault Value Package

- Includes:
- 1-TP2021 Champion pole vault pit.
 - 1-TP2021A all weather cover.
 - 1-TPVS6 pair pole vault standards 6' - 18'.
 - 1-TFG14-1 14' 10" fiberglass crossbar.
 - 1-TPPAD pole vault standard pad.
 - 13 YEAR WARRANTY

TVPHPV F Class 250, 450 lbs

CALL FOR PRICE



YOUR "ONE-STOP" SOURCE FOR ALL YOUR ATHLETIC EQUIPMENT NEEDS

PRICES SUBJECT TO CHANGE & AVAILABILITY PLUS SHIPPING | VOLUME DISCOUNTS AVAILABLE | COOPERATIVE PURCHASING CONTRACT PRICING FOR 50 STATES

BEAM CLAY®

Stackhouse High Jump Pits

WHOLESALE PRICE LIST
EFFECTIVE: JANUARY 1, 2021

High Jump Pits

ELEMENTARY/PROVIDENCE HIGH JUMP SYSTEMS

- Made In America by Stackhouse.
- Buy American Quality.
- Sixty Five Years on.
- Thirteen Year Warranty backed by American Sweat, Materials, and Workmanship.
- American made Earth-Cell foam. Exclusive and Trademarked.
- Produced from renewable resources such as Soy.
- Reduces America's dependency on fossil fuels.
- Lessens energy demand for a smaller environmental footprint
- Comfort. Protection. Performance
- Outstanding (Colors won't fade) UV Protection
- Excellent Strength and Wear Longevity
- Comfort Carry Handles.
- Made to Order: Guarantee ship within 1-2 weeks



Providence High Jump Pit



Providence High Jump Pit

Ideal high jump pit for High School or Middle School looking for the best buy on a pit not containing a top pad. Meets all High School Specifications. Pit uses a mesh "table cloth" style skirt to hold buns together. Comes in 12 colors and is 16' x 8' x 24". Guaranteed satisfaction with a 13 year warranty.

TB816	F Class 250, 235 lbs	CALL FOR PRICE
TB816A	All Weather Cover, UPS 30 lbs	CALL FOR PRICE
TB816G	Ground Cover, UPS 30 lbs	CALL FOR PRICE

Providence High Jump Value Package

- Includes:
- 1-TB816 Providence high jump pit.
 - 1-TB816A Providence high jump pit all weather cover.
 - 1-TBS pair budget high jump standards.
 - 1-TFG13-1 13' 1 1/2" fiberglass crossbar.
 - 13 YEAR WARRANTY

TVPBHJ	F Class 250, 309 lbs	CALL FOR PRICE
---------------	----------------------	----------------

Elementary High Jump System

- Available in "Straight Front" design.
- Not intended for High School use.
- 1 piece base section.
- 13 YEAR WARRANTY. 12' W x 6' D x 24" H; pit

TH612	F Class 250, 115 lbs	CALL FOR PRICE
TH612A	All Weather Cover, UPS 30 lbs	CALL FOR PRICE
TH612G	Ground Cover, UPS 30 lbs	CALL FOR PRICE

Elementary School High Jump Value Package

- Includes:
- 1-TH612 Elementary high jump pit.
 - 1-TH612A Elementary high jump pit all weather cover.
 - 1-TBS pair budget high jump standards.
 - 1-TFG13-1 13' 1 1/2" fiberglass crossbar.
 - 13 YEAR WARRANTY

TVPEHJ	F Class 250, 189 lbs	CALL FOR PRICE
---------------	----------------------	----------------



Elementary High Jump Pit



YOUR "ONE-STOP" SOURCE FOR AMERICA'S BASEBALL, SOFTBALL & SPORTS SURFACES & SUPPLIES!

PRICES SUBJECT TO CHANGE & AVAILABILITY PLUS SHIPPING | VOLUME DISCOUNTS AVAILABLE | COOPERATIVE PURCHASING CONTRACT PRICING FOR 50 STATES

BEAM CLAY®

Stackhouse High Jump Pits

WHOLESALE PRICE LIST
EFFECTIVE: JANUARY 1, 2021

High Jump Pits



Challenger Straight Front High Jump Pit

H.S. High Jump Value Package

- Includes:
- 1-TH816 Challenger high jump pit.
 - 1-TH816A Challenger high jump pit all weather cover.
 - 1-TRSS pair steel roll away high jump standards.
 - 1-TFG13-1 13' 1 1/2" fiberglass crossbar.
 - 13 YEAR WARRANTY

TVPHJ F Class 250, 389 lbs

CALL FOR PRICE

Challenger High Jump System

- Meets NFHS Standards.
- Available in "Straight Front" design.
- 3 base sections are buckled at ends, and seams are covered with 3" Velcro strips. The sections are covered by a 2" top pad.
- 13 YEAR WARRANTY.

TH816 16' 6" W x 8' D x 26" H; pit and top pad
F Class 250, 284 lbs

CALL FOR PRICE

TH816A All Weather Cover, UPS 33 lbs

CALL FOR PRICE

TH816G Ground Cover, UPS 33 lbs

CALL FOR PRICE

H.S. Cut-out High Jump Value Package

- Includes:
- 1-THC1016 Challenger cut-out high jump pit.
 - 1-THC1016A Challenger high jump pit all weather cover.
 - 1-TRSS pair steel roll away high jump standards.
 - 1-TFG13-1 13' 1 1/2" fiberglass crossbar.
 - 13 YEAR WARRANTY

TVPOHJ F Class 250, 445 lbs

CALL FOR PRICE

Challenger High Jump System - Cut-out Front

- Meets NFHS Standards.
- Also available in "Straight Front" design.
- 3 base sections are buckled at ends, and seams are covered with 3" Velcro strips. The sections are covered by a 2" top pad.
- 13 YEAR WARRANTY.

THCO1016 16' 6" W x 8' D x 26" H; pit and top pad

CALL FOR PRICE

THCO1016A All Weather Cover

CALL FOR PRICE

THCO1016G Ground Cover

CALL FOR PRICE



Challenger Cut-out Front High Jump Pit

HIGH SCHOOL / CHALLENGER HIGH JUMP SYSTEMS

- Made In America by Stackhouse.
- Buy American Quality.
- Sixty Five Years on.
- Thirteen Year Warranty backed by American Sweat, Materials, and Workmanship.
- American made Earth-Cell foam. Exclusive and Trademarked.
- Produced from renewable resources such as Soy.

- Reduces America's dependency on fossil fuels.
- Lessens energy demand for a smaller environmental footprint
- Comfort. Protection. Performance
- Outstanding (Colors won't fade) UV Protection
- Excellent Strength and Wear Longevity
- Comfort Carry Handles.
- Made to Order: Guarantee ship within 1-2 weeks



YOUR "ONE-STOP" SOURCE FOR AMERICA'S BASEBALL, SOFTBALL & SPORTS SURFACES & SUPPLIES!

PRICES SUBJECT TO CHANGE & AVAILABILITY PLUS SHIPPING | VOLUME DISCOUNTS AVAILABLE | COOPERATIVE PURCHASING CONTRACT PRICING FOR 50 STATES

BEAM CLAY®

Cantabrian High Jump Pits

WHOLESALE PRICE LIST
EFFECTIVE: JANUARY 1, 2021



High Jump Pits



International High Jump System by Cantabrian



- Meets NCAA, IAAF & NFHS Standards.
- Available in "Front Cut-Out" and "Straight Front" designs.
- 3 base sections are buckled and seams covered with 3" Velcro strips and 2" top pad.
- 13 YEAR WARRANTY.

THSF1018	18' W x 10' D x 26" H, Straight Front, pit and top pad. F Class 250, 374 lbs	CALL FOR PRICE
THSF1018A	Straight Front All Weather Cover UPS 33 lbs	CALL FOR PRICE
THSF1018G	Straight Front Ground Cover UPS 33 lbs	CALL FOR PRICE
THCO1018	18' W x 10' D x 26" H, Front Cut-Out, pit and top pad. F Class 250, 374 lbs	CALL FOR PRICE
THCO1018A	Front Cut-Out All Weather Cover UPS 33 lbs	CALL FOR PRICE
THCO1018G	Front Cut-Out Ground Cover UPS 33 lbs	CALL FOR PRICE

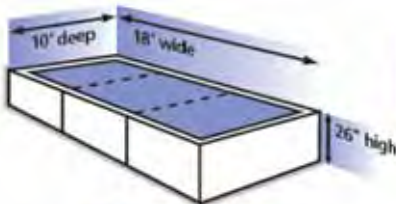

Straight front

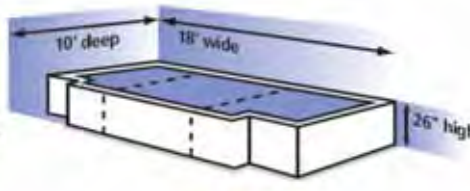

Cut-out



TRASC

International High Jump Value Package by Cantabrian

Includes:

- 1-THCO1018 International high jump pit.
- 1-THCO1018A International high jump pit all weather cover.
- 1-TRASC pair aluminum roll away high jump standards.
- 1-TFG13-1 13' 1 1/2" fiberglass crossbar.
- 13 YEAR WARRANTY

TVPCHJ	F Class 250, 450 lbs	CALL FOR PRICE
---------------	----------------------	----------------

INTERNATIONAL HIGH JUMP SYSTEM BY CANTABRIAN

- Made In America by Stackhouse.
- Buy American Quality.
- Sixty Five Years on.
- Thirteen Year Warranty backed by American Sweat, Materials, and Workmanship.
- American made Earth-Cell foam. Exclusive and Trademarked.
- Produced from renewable resources such as Soy.

- Reduces America's dependency on fossil fuels.
- Lessens energy demand for a smaller environmental footprint
- Comfort. Protection. Performance
- Outstanding (Colors won't fade) UV Protection
- Excellent Strength and Wear Longevity
- Comfort Carry Handles.
- Made to Order: Guarantee ship within 1-2 weeks



YOUR "ONE-STOP" SOURCE FOR AMERICA'S BASEBALL, SOFTBALL & SPORTS SURFACES & SUPPLIES!

PRICES SUBJECT TO CHANGE & AVAILABILITY PLUS SHIPPING | VOLUME DISCOUNTS AVAILABLE | COOPERATIVE PURCHASING CONTRACT PRICING FOR 50 STATES

BEAM CLAY®

High Jump Standards

WHOLESALE PRICE LIST
 EFFECTIVE: JANUARY 1, 2021

High Jump Standards



Telescoping Riser



Telescoping Riser



Adjustable Height

Cantabrian Elite International Rollaway High Jump standards

- Features unique 4" x 4 1/2" aluminum extruded profile.
- Internal key adjusts upright crossbar rest to telescope at desired height.
- "Brake shoe" design locks upright at desired height.
- Easily adjusts from 2' - 9' measurements in both Standard and Metric.
- Powder coated steel rollaway base.
- Easy turn adjustment knobs for leveling base.
- Meets IAAF, NCAA & NFHS rules.

TCEIR (each) UPS (1) 52 lbs ships dimensional, (1) 62 lbs

\$1,039

Cantabrian Aluminum Rollway High Jump Standards

- High Quality 3" Diameter Aluminum extrusion uprights use internal guide for telescoping crossbar riser. Easy spin knob to lock in height and height adjustment finger insures accurate reading of measurement tape.
- Height adjusts from 2' - 8' in 1/4" increments also have metric scale form 69 - 250 cm. Gives measurement for both upper and lower crossbar rest.
- Powder coated Steel T-Base uses counter balance weight to keep base from rocking. Uses easy adjust leveling screws for quick set up on any surface.
- 24" base with rollaway feature makes for easy taking on and off the field.
- Meets all NFHS, NCCA & IAAF Specifications. Ideal for High School and College use.

TRASC (pair) UPS (2) pkgs, (1) 28 lbs, (1) 9 lbs

\$739

YOUR "ONE-STOP" SOURCE FOR AMERICA'S BASEBALL, SOFTBALL & SPORTS SURFACES & SUPPLIES!

PRICES SUBJECT TO CHANGE & AVAILABILITY PLUS SHIPPING | VOLUME DISCOUNTS AVAILABLE | COOPERATIVE PURCHASING CONTRACT PRICING FOR 50 STATES

BEAM CLAY®

High Jump Standards

WHOLESALE PRICE LIST
 EFFECTIVE: JANUARY 1, 2021

High Jump Standards



A. Budget High Jump Standard

- Water Resistant enamel finish.
- Adjusts from 1' to 7' in 1/4" intervals.
- Economical purchase!

TBS Pair UPS 2 pkgs, (1) 8 lbs
 Ships Dimensional, (1) 30 lbs

\$229

B. Excelsior High Jump Standard

- Zinc plated water resistant uprights.
- Heavy-duty base.
- Suitable for H.S. or College.
- Adjusts from 2' to 8' in 1/4" intervals.
- Metric scale in cm 62 to 244.

TEXS Pair UPS 2 pkgs, (1) 25 lbs, (1) 36 lb

\$425

C. Steel Roll Away High Jump Standard

- Zinc plated water resistant uprights.
- 16" base with roll away feature.
- Suitable for H.S. or College.
- Adjusts from 2' to 8' in 1/4" intervals.
- Metric scale in cm 62 to 244.

TRSS Pair UPS 2 pkgs, (1) 26 lbs, (1) 40 lb

\$659

D. Premier High Jump Standards

- Stackhouse's premiere H.J. standard!
- Meets IAAF, NCAA & NFHS rules.
- 2.5" D X 5.5" W aluminum uprights with telescoping riser.
- Steel roll away base with adjusting leveling screws.
- Adjusts from 1.5' to 9'.
- Measurements in Standard and Metric.

TOHJS Pair UPS 2 pkgs, (1) 45 lbs
 Ships Dimensional, (1) 62 lbs

\$959

YOUR "ONE-STOP" SOURCE FOR AMERICA'S BASEBALL, SOFTBALL & SPORTS SURFACES & SUPPLIES!

PRICES SUBJECT TO CHANGE & AVAILABILITY PLUS SHIPPING | VOLUME DISCOUNTS AVAILABLE | COOPERATIVE PURCHASING CONTRACT PRICING FOR 50 STATES

BEAM CLAY®

High Jump & Pole Vault Accessories

WHOLESALE PRICE LIST
EFFECTIVE: JANUARY 1, 2021

High Jump & Pole Vault Accessories

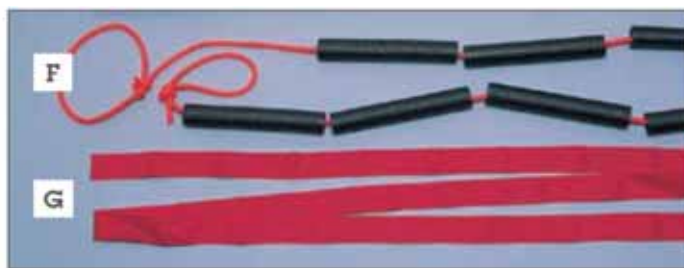

E. Stackhouse Official Fiberglass Crossbar

TFG13-1	13' 1 1/2" competition, 6 lbs. F Class 70	\$110
TFG14-1	14' 10" competition, 6 lbs. F Class 70	\$115
TFP-13	13' 1 1/2" practice, 6 lbs. F Class 70	\$95
TFP-14	14' 10" practice, 6 lbs. F Class 70	\$99

F. Elastic Practice Crossbar

Fluorescent orange crossbar has 1 1/2" polyfoam sections to simulate actual size of official crossbar. Speeds up practice, saves crossbar and prevents injuries from falling crossbars. For use with pole vault or high jump.

TEPCB	UPS 1 lb	\$30
--------------	----------	------

G. Nylon Break Away Crossbar for High Jumper

Upon contact hook and loop connection gives way, letting nylon crossbar fall to ground. Excellent for training and practice. Reduces injuries. Uses hook and loop for breakaway and to adjust length.

TNTC	UPS 1 lb	\$40
-------------	----------	------

H. High Jump Measure

THJM	High jump; 3' 1" to 8' 3" UPS 4 lbs.	\$285
-------------	--------------------------------------	-------

I. Pole Vault Measure

TPVM	Pole vault; 4' 9" to 20' 4" UPS 6 lbs	\$315
-------------	---------------------------------------	-------

J. Adjustable Crossbar Lifter

Extends crossbar to 15'6"

TACL	UPS 2 pkgs, (1) 10 lbs + AH, (1) 3 lb	\$185
-------------	---------------------------------------	-------

K. Crossbar Center Lifter

This all-steel lifter addresses the need for only one person to put up a crossbar. Simply screw the lifter to a broken crossbar or pole and it's ready for use. Handle and screws not included.

TCBCL	UPS 3 lbs	\$85
--------------	-----------	------

L. Crossbar End Lifter

Made to slide over the end of any vaulting pole, this lifter is the most convenient on the market.

TCBEL	UPS 5 lbs	\$85
--------------	-----------	------

YOUR "ONE-STOP" SOURCE FOR AMERICA'S BASEBALL, SOFTBALL & SPORTS SURFACES & SUPPLIES!

PRICES SUBJECT TO CHANGE & AVAILABILITY PLUS SHIPPING | VOLUME DISCOUNTS AVAILABLE | COOPERATIVE PURCHASING CONTRACT PRICING FOR 50 STATES

BEAM CLAY®

Cantabrian Pole Vault Pits

WHOLESALE PRICE LIST
EFFECTIVE: JANUARY 1, 2021

POLE VAULT PITS 

Double-sided coaches box offers twice the life.

Extra-tough monster mesh resists tearing. Vinyl-coated polyester yarn offers superior water-repelling characteristics.

Reinforced flaps boast a 3" Velcro locking system.

3 back buns are interchangeable to evenly distribute wear.

Top pad cut out showing flap.

Zinc coated, rust resistant snap rings and snap hooks

TP2224
22'x24'x37"

22oz. marine grade vinyl is UV and mildew-resistant

Double and triple-stitched seams prevent separation.

Vinyl-backed reinforced 2" military grade nylon poly web handles.

Patented Earthcell™ foam is a flexible bio-based alternative to petroleum-based padding. Its superior performance comes from enhanced cell integrity.

Impact-safe cross-tunnel construction distributes impact force over the pit's surface area, helping decelerate the vaulter for a safe landing.

AMERICAN BUILT | **IAAF, NCAA & NFHS CERTIFIED** | **13 YEAR WARRANTY**

YOUR "ONE-STOP" SOURCE FOR AMERICA'S BASEBALL, SOFTBALL & SPORTS SURFACES & SUPPLIES!

PRICES SUBJECT TO CHANGE & AVAILABILITY PLUS SHIPPING | VOLUME DISCOUNTS AVAILABLE | COOPERATIVE PURCHASING CONTRACT PRICING FOR 50 STATES

PARTAC PEAT CORPORATION
ONE KELSEY PARK, GREAT MEADOWS, NEW JERSEY 07838

800-247-BEAM (2326) • (908) 637-4191 • FAX (908) 637-8421
www.beamclay.com • sales@beamclay.com
Bid Term - 5/9/18 - 5/8/20; Extended to 5/8/21; Extended to 5/8/22

BEAM CLAY®

Stackhouse Pole Vault Pits

WHOLESALE PRICE LIST
 EFFECTIVE: JANUARY 1, 2021

Pole Vault Pits



H.S. Pole Vault Value Package

- Includes:
- 1-TP2021 Champion pole vault pit.
 - 1-TP2021A all weather cover.
 - 1-TPVS6 pair pole vault standards 6' - 18'.
 - 1-TFG14-1 14' 10" fiberglass crossbar.
 - 1-TPPAD pole vault standard pad.
 - 13 YEAR WARRANTY

TVPHPV F Class 250, 1359 lbs

CALL FOR PRICE

Champion Pole Vault Pit

- 22 oz. Reinforced vinyl "coated both sides".
- 2" Polyurethane spike resistant top pad.
- Heavy duty webbing handles.
- Specially designed foam modules with varying densities.
- Double stitched seams with nylon non-oxidizing zippers.
- Also available in two colors at NO EXTRA CHARGE! [hide]
- 13 YEAR WARRANTY.

TP2021 20' x 21' x 26"; pit and top pad; meets NFHS rules, F Class 250, 953 lbs

CALL FOR PRICE

TP2021A All Weather Cover, UPS 84 lbs

CALL FOR PRICE

TP2021G Ground Cover, UPS 75 lbs

CALL FOR PRICE

High School / Champion Pole Vault Pit

- Made In America by Stackhouse.
- Buy American Quality.
- Sixty Five Years on.
- Thirteen Year Warranty backed by American Sweat, Materials, and Workmanship.
- American made Earth-Cell foam. Exclusive and Trademarked.
- Produced from renewable resources such as Soy.

- Reduces America's dependency on fossil fuels.
- Lessens energy demand for a smaller environmental footprint
- Comfort. Protection. Performance
- Outstanding (Colors won't fade) UV Protection
- Excellent Strength and Wear Longevity
- Comfort Carry Handles.
- Made to Order: Guarantee ship within 3 weeks

Pit Vinyl Colors

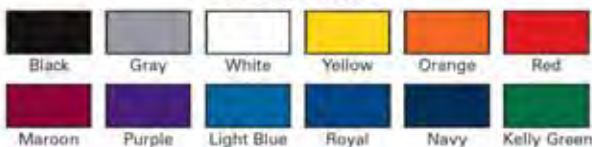

Mesh Colors



YOUR "ONE-STOP" SOURCE FOR AMERICA'S BASEBALL, SOFTBALL & SPORTS SURFACES & SUPPLIES!

PRICES SUBJECT TO CHANGE & AVAILABILITY PLUS SHIPPING | VOLUME DISCOUNTS AVAILABLE | COOPERATIVE PURCHASING CONTRACT PRICING FOR 50 STATES

BEAM CLAY®

WHOLESALE PRICE LIST
EFFECTIVE: JANUARY 1, 2021

Cantabrian Pole Vault Pits

Pole Vault Pits

H.S. Pole Vault Value Package by Cantabrian - 32" high
Includes:

- 1-TP2021X Cantabrian H.S. pole vault pit 32" high.
- 1-TP2021XA All Weather Cover.
- 1-TOPVS pair pole vault standards 6' - 18'.
- 1-TFG14-1 14' 10" fiberglass crossbar.
- 1-TPPAD64 pole vault standard pad.
- 13 YEAR WARRANTY

TVPXPV F Class 250, 1513 lbs

CALL FOR PRICE

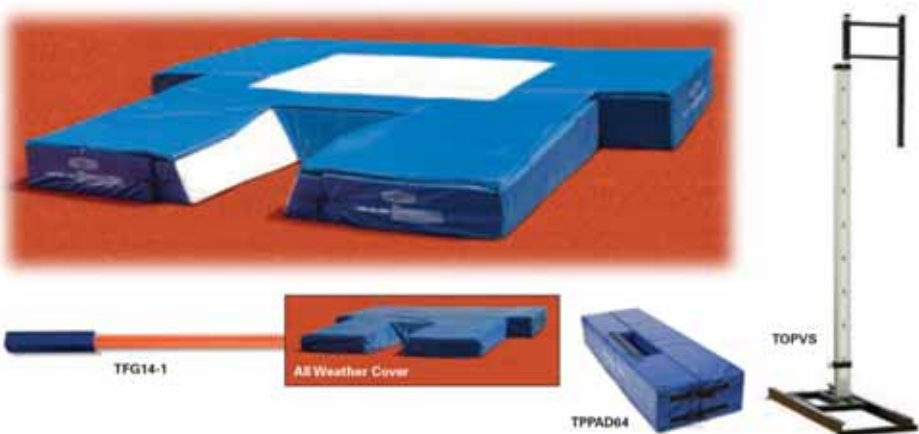

Champion Pole Vault Pit - 32" High

- 18 oz. Reinforced vinyl "coated both sides".
- 2" Polyurethane spike resistant top pad.
- Heavy duty webbing handles.
- Specially designed foam modules with varying densities.
- Double stitched seams with nylon non-oxidizing zippers.
- Also available in two colors at NO EXTRA CHARGE! [hide]
- 13 YEAR WARRANTY.

TP2021X 20' x 21' x 32"; pit and top pad; meets NFHS rules, F Class 250, 1107 lbs

CALL FOR PRICE

TP2021XA All Weather Cover, UPS 84 lbs

CALL FOR PRICE

TP2021XG Ground Cover, UPS 75 lbs

CALL FOR PRICE

High School / Champion Pole Vault Pit

- Made In America by Stackhouse.
- Buy American Quality.
- Sixty Five Years on.
- Thirteen Year Warranty backed by American Sweat, Materials, and Workmanship.
- American made Earth-Cell foam. Exclusive and Trademarked.
- Produced from renewable resources such as Soy.

- Reduces America's dependency on fossil fuels.
- Lessens energy demand for a smaller environmental footprint
- Comfort. Protection. Performance
- Outstanding (Colors won't fade) UV Protection
- Excellent Strength and Wear Longevity
- Comfort Carry Handles.
- Made to Order: Guarantee ship within 3 weeks



YOUR "ONE-STOP" SOURCE FOR AMERICA'S BASEBALL, SOFTBALL & SPORTS SURFACES & SUPPLIES!

PRICES SUBJECT TO CHANGE & AVAILABILITY PLUS SHIPPING | VOLUME DISCOUNTS AVAILABLE | COOPERATIVE PURCHASING CONTRACT PRICING FOR 50 STATES

BEAM CLAY®

Cantabrian Pole Vault Pits

WHOLESALE PRICE LIST
EFFECTIVE: JANUARY 1, 2020

Pole Vault Pits



Padding required per Rule 7, section 4, article 11 of the NFHS rule book.

All Weather Cover



Cantabrian PV Pit 22' x 24' x 28"

- 18 oz. Reinforced vinyl "coated both sides".
- 2" Polyurethane spike resistant top pad.
- Heavy duty webbing handles.
- Specially designed foam modules with varying densities.
- Double stitched seams with nylon non-oxidizing zippers.
- Also available in two colors at NO EXTRA CHARGE! [hide]
- 13 YEAR WARRANTY.

TP2224X	22' x 24' x 28"; pit and top pad; meets IAAF, NCAA & NFHS rules. F Class 250, 1319 lbs	CALL FOR PRICE
TP2224XA	All Weather Cover, UPS 75 lbs	CALL FOR PRICE
TP2224XG	Ground Cover, UPS 70 lbs	CALL FOR PRICE

International Pole Vault Pit by Cantabrian

- 18 oz. Reinforced vinyl "coated both sides".
- 2" Polyurethane spike resistant top pad.
- Heavy duty webbing handles.
- Specially designed foam modules with varying densities.
- Double stitched seams with nylon non-oxidizing zippers.
- Also available in two colors at NO EXTRA CHARGE! [hide]
- 13 YEAR WARRANTY.

TP2224	22' x 24' x 32"; pit and top pad; meets IAAF, NCAA & NFHS rules. F Class 250, 1519 lbs	CALL FOR PRICE
TP2224A	All Weather Cover, UPS 84 lbs	CALL FOR PRICE
TP2224G	Ground Cover, UPS 75 lbs	CALL FOR PRICE



Cantabrian Pole Vault Value Package

Includes:

- 1-TP2224X Cantabrian pole vault pit (22' x 24' x 28").
- 1-TP2224XA All Weather Cover.
- 1-TCPVS pair premier Cantabrian pole vault standards 8'6" - 21'.
- 1-TFG14-1 14' 10" fiberglass crossbar.
- 1-TPPAD64 pole vault standard pad.
- 13 YEAR WARRANTY

TVPCPV	F Class 250, 1950 lbs	CALL FOR PRICE
---------------	-----------------------	----------------

International Pole Vault Value Package by Cantabrian

Includes:

- 1-TP2224 International pole vault pit (22' x 24' x 32").
- 1-TP2224A All Weather Cover.
- 1-TCPVS pair premier aluminum pole vault standards 9' - 21'.
- 1-TFG14-1 14' 10" fiberglass crossbar.
- 1-TPPAD92 pole vault standard pad.
- 13 YEAR WARRANTY

TVPIPV	F Class 250, 2127 lbs	CALL FOR PRICE
---------------	-----------------------	----------------

YOUR "ONE-STOP" SOURCE FOR AMERICA'S BASEBALL, SOFTBALL & SPORTS SURFACES & SUPPLIES!

PRICES SUBJECT TO CHANGE & AVAILABILITY PLUS SHIPPING | VOLUME DISCOUNTS AVAILABLE | COOPERATIVE PURCHASING CONTRACT PRICING FOR 50 STATES

BEAM CLAY®

WHOLESALE PRICE LIST EFFECTIVE: JANUARY 1, 2021

Vault Boxes

Vault Boxes

A. Stainless Steel Vault Box

Smooth finished stainless box made of 12 gauge stainless steel will not rust, crack or split. The preferred box for universities, colleges & high schools where they are looking for a top quality box that will give years of trouble-free use.

TSSVB UPS 65 lbs. Ships Dimensional **\$739**

Steel Lid

For TSVB & TSSVB.

TSVBL UPS 29 lbs. Ships Dimensional **\$315**

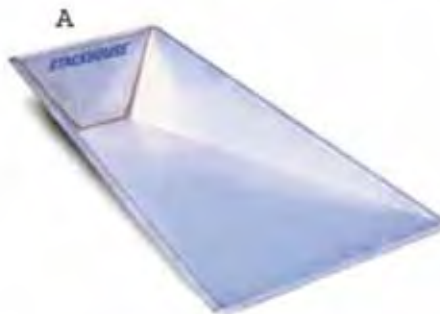

B. Steel Vault Box

Heavy gauge steel featuring a curved front lip which eliminates it as a pole obstacle even when the runway is worn down. Has flared sides and 105 degree angle.

TSVB UPS 43 lbs. Ships Dimensional **\$359**

Steel Lid

For TSVB & TSSVB.

TSVBL UPS 29 lbs. Ships Dimensional **\$315**



C. Welded Aluminum Vault Box

Thick wall 5052 aluminum welded construction ensures this vault box will last the lifetime of your track. The 1/8" walls and 1/4" bottom and backstop make this the strongest vault box in the industry. Meets all NFHS, NCAA & IAAF Specifications.

TWAVB UPS 24 lbs. Ships Dimensional **\$479**

Aluminum Lid

Aluminum lid is 1/4" thick and uses supports in the middle to ensure lid always has flush appearance. Lid sits flush with top of vault box and may be covered with all-weather track material.

TWAVBL UPS 12 lbs. Ships Dimensional **\$455**



D. Cast Aluminum Vault Box

This high quality vault box is designed to give years of trouble-free use. The thick walled aluminum casting will not warp, crack or rust. Inside corners are rounded for easy rotation of pole in box. Ideal for universities, colleges & high schools who are looking for a top of the line vault box that meets all IAAF, NCAA & NFHS specifications.

TCAVB UPS 66 lbs **\$775**

Cast Aluminum Lid

This lid is designed to give attractive level top surface for when TCAVB is not in use. Lid has textured finish to match look of TCAVB but may also have synthetic surface applied to match runway.

TCAVBL UPS 33 lbs. Ships Dimensional **\$385**

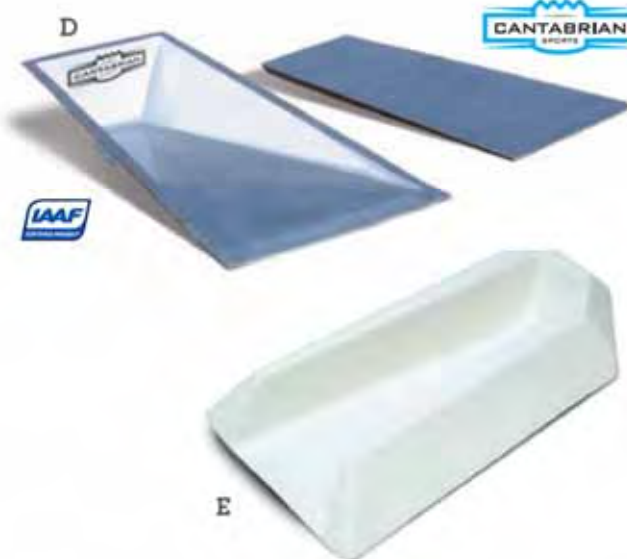

E. Pole Vault Slide Box

This lightweight fiberglass slide box is reinforced for years of heavy use. Bright white, it is highly visible and slides straight away. Use indoors or out for fast development of the most crucial part of the vault: the run and plant.

TPVSB UPS 21 lbs. Ships Dimensional **\$465**

YOUR "ONE-STOP" SOURCE FOR AMERICA'S BASEBALL, SOFTBALL & SPORTS SURFACES & SUPPLIES!

PRICES SUBJECT TO CHANGE & AVAILABILITY PLUS SHIPPING | VOLUME DISCOUNTS AVAILABLE | COOPERATIVE PURCHASING CONTRACT PRICING FOR 50 STATES

BEAM CLAY®

Pole Vault Accessories

WHOLESALE PRICE LIST
EFFECTIVE: JANUARY 1, 2021

Value Packs & Pole Accessories

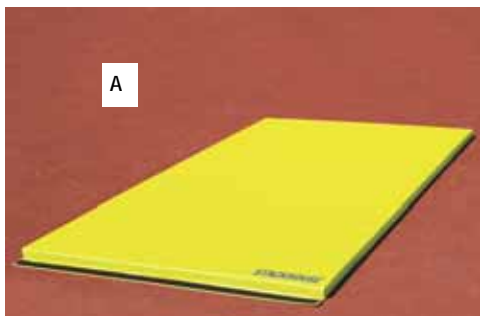

A

A. Vault Protective Padding

This protective padding is designed to be laid on the outside of your pit and cover any or all hard surfaces that are exposed. Made of 2" high-density foam and heavy 18 oz. yellow vinyl, this mat can be attached to another mat with existing velcro flaps on both ends. Comes in 4' x 8' yellow sections.

TVP 4' x 8, Class 70, 20 lbs

\$415



B

B. Vault Box Collar

Meets ASTM F2949-12 standard and is compliant with NCAA/NFHS 2015 rule. In-ground anchor system limits collar slipping. 3" foam covered with heavy 18oz yellow vinyl.

TVC 33" foam, Class 70, 38 lbs.

\$645

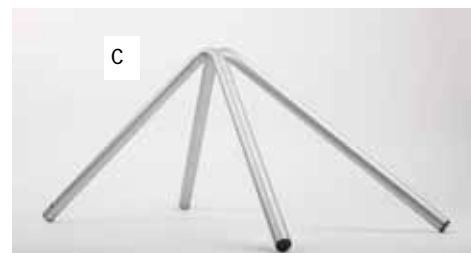

C

C. Weather Cover Insert

This weather cover insert helps keep rain from puddling on pit. 1" coated steel frame with capped ends for protection.

TWCI UPS 5 lbs.

\$49

E. H.S. Girl's Throws Value Pack

Girl's package includes:

- 1-TWRD 1k rubber discus.
- 1-T52 1k blue competition discus.
- 1-T62 1k red low spin discus.
- 1-TIS4 4k cast iron shot,
- 1-TIWS104 4k 104mm turned shot.
- 2-TVCBS vinyl shot & discus carry bag with strap.

TTP-G UPS 30 lb

\$235



D

D. H.S. Boy's Throws Value Pack

Boy's package includes:

- 1-THRD 1.6k rubber discus.
- 1-T51 1.6k blue competition discus.
- 1-T61 1.6k red low spin discus.
- 1-TIS12 12 lb cast iron shot.
- 1-TIWS115 12 lb 115mm turned shot.
- 2-TVCBS vinyl shot & discus carry bag with strap.

TTP-B UPS 41 lbs

\$250



E

IMPLEMENT SELECTION CHARTS

DISCUS SELECTION CHART

H.S. GIRLS

RANGE	RIM WEIGHT
100' to 125'	70% to 73%
120' to 150'	73% to 75%
140' to 160'	75% to 80%
150' to 165'	78% to 85%
160' or more	85% to 89%
175' to 190'	85% to 90%

H.S. BOYS

RANGE	RIM WEIGHT
100' to 130'	70% to 73%
125' to 150'	73% to 75%
145' to 160'	75% to 80%
155' to 170'	78% to 85%
165' to 180'	85% to 89%
190' or more	88% to 91%

HAMMER COMPETITION SPECS:

Women H.S. to 49	4 kilo.
Women 50 plus	3 kilo.
H.S. boys	12 lbs.
College/masters men to age 49	16 lbs.
Men 50-59	6 kilo.
Men 60-69	5 kilo.
Men 70 plus	4 kilo.

DISCUS COMPETITION SPECS:

Women, H.S. plus	1 kilo.
H.S. boys	1.6 kilo.
College-masters men to 49	2 kilo.
Int'l jr. men (19 & under)	1.75 kilo.
Men 50 to 59	1.5 kilo.
Men 60 plus	1 kilo.

SHOT COMPETITION SPECS:

Women from H.S. through age 49	4.0 kilo.
Women age 50 plus	3.0 kilo.
Boys: H.S.	12 lbs.
Men to age 49	16 lbs.
Men 50-59	6.0 kilo.
Men 60-69	5.0 kilo.
Men 70 plus	4.0 kilo.

YOUR "ONE-STOP" SOURCE FOR AMERICA'S BASEBALL, SOFTBALL & SPORTS SURFACES & SUPPLIES!

PRICES SUBJECT TO CHANGE & AVAILABILITY PLUS SHIPPING | VOLUME DISCOUNTS AVAILABLE | COOPERATIVE PURCHASING CONTRACT PRICING FOR 50 STATES

PARTAC PEAT CORPORATION
ONE KELSEY PARK, GREAT MEADOWS, NEW JERSEY 07838

800-247-BEAM (2326) • (908) 637-4191 • FAX (908) 637-8421
www.beamclay.com • sales@beamclay.com
Bid Term - 5/9/18 - 5/8/20; Extended to 5/8/21; Extended to 5/8/22

BEAM CLAY®

High Jump / Pole Vault Accessories

WHOLESALE PRICE LIST
EFFECTIVE: JANUARY 1, 2021

Pole Vault Standards



A. Pole Vault Standards

Ideal for beginner to advanced, male & female vaulters because of its height adjustment capability. Adjusts from 6' to 16' on offset riser setting #1. Need additional height? Reset the offset riser for a range of 8' to 18'.

- Adjusts from 6' to 16' & 8' to 18'.
- Easy grip handles for height adjustment and "Spin t-handles" to lock riser in place.
- 60" base with 32" adjustability behind the box.
- Chrome plated rust resistant steel risers.

TPVS6 Pair; 6' - 18' F Class 60, 198 lbs **\$1,550**

B. Pole Vault Standard Pad

Fits Stackhouse TPVS6 standards. Snug fitting pad gives excellent protection at a budget price. 17" x 62" inside dimension fits most bases.

TPPAD Pair; 17" x 62" inside
UPS 40 lbs each, Ships Dimensional **CALL FOR PRICE**

Pole Vault Standards—Universal 3' Extension
Allows lowering crossbar additional 3'. For beginning vaulters. Fits all crossbar standards.

TPVSEU Pair; 3' UPS 10 lbs. **\$205**



C. Premier Aluminum Pole Vault Standards

Stackhouse's top of the line lightweight standard, with aluminum uprights and steel base for stability. • Meets IAAF, NCAA and NFHS Rules.

- 2.5" D x 5.5" W aluminum uprights with telescoping riser.
- 72" L x 24" W steel base with leveling devices on four corners and anchoring points.
- Adjusts from 9' to 21'; marked in both Standard and Metric measurement.
- Offset risers have easy 6" height adjustment increments.
- Includes 75mm and 55mm crossbar rest pegs for NCAA & IAAF events.
- Uprights mounted on offset steel carriage that rides on poly wheels. Adjusts from 0 - 32" / 80 cm.

TOPVS Pair; 9' - 21' F Class 60, 4 pkgs 385 lbs **\$2,495**

D. Offset Base Protector Pad

Fits Stackhouse TOPVS. Works on all offset riser standards. Made of high density foam with 18 oz. polyester vinyl coated on both sides. Adjustment measurement scale on top of pad.

TPFPAD92 Pair; 90"l x 32 1/2"w x 17 1/2"h
F Class 100, 95 lbs **CALL FOR PRICE**

Pole Vault Standards - Premier 3' Extensions

Fits TOPVS standards and similar models and styles. Call for details.

TPVSEO Pair; 3' UPS 10 lbs **\$170**

YOUR "ONE-STOP" SOURCE FOR AMERICA'S BASEBALL, SOFTBALL & SPORTS SURFACES & SUPPLIES!

PRICES SUBJECT TO CHANGE & AVAILABILITY PLUS SHIPPING | VOLUME DISCOUNTS AVAILABLE | COOPERATIVE PURCHASING CONTRACT PRICING FOR 50 STATES

BEAM CLAY®

WHOLESALE PRICE LIST
 EFFECTIVE: JANUARY 1, 2020

Pole Vault Standards

Pole Vault Standards



E. Cantabrian Pole Vault Standards

New International/Collegiate design standards.

- Meets IAAF, NCAA & NFHS Rules.
- All aluminum construction. Uses 4" diameter extrusion for upright with telescoping aluminum riser.
- Standards adjust from 8' 6" to 21' (Standard & Metric) with easy turn locking knob that use "Reader Finger" for easy reading of height adjustment.
- Offset riser is made of aluminum with easy view "Optic Yellow" finish. Offset riser attaches to upright riser with through bolts and use nylock nuts to insure firm attachment. Crossbar pens every 6" for quick height adjustment.
- Base is all aluminum channel, marked for location of carriage. Threaded orange stop bumper can be adjusted to insure carriage does not go past zero.

TCPVS Pair; 8'6" - 21' F Class 60, 4 Pkgs 305 lbs **\$3,150**

F. Cantabrian Standard Pad

For High School Pole Vault Pits.

TPPAD64 UPS 45 LBS each, Ships Dimensional

CALL FOR PRICE

G. Cantabrian International Crossbars

High quality pulltruded fiberglass bar. Special optic colors give jumper easy height visualization. Meets all NFHS, NCAA & IAAF specifications.

TCFHJ13 13' 1 1/2" High Jump Crossbar 6lbs, frt class 70 **\$139**

TCPV14 14' 10" Pole Vault Crossbar F 6lbs, frt class 70 **\$155**

Replacement Crossbar End (not shown)

TCEND International/College UPS 2 lbs **\$17**

YOUR "ONE-STOP" SOURCE FOR AMERICA'S BASEBALL, SOFTBALL & SPORTS SURFACES & SUPPLIES!

PRICES SUBJECT TO CHANGE & AVAILABILITY PLUS SHIPPING | VOLUME DISCOUNTS AVAILABLE | COOPERATIVE PURCHASING CONTRACT PRICING FOR 50 STATES

BEAM CLAY®

WHOLESALE PRICE LIST
EFFECTIVE: JANUARY 1, 2021

Shot Put Throwing Sector Surfaces



SHOT PUT THROWING SECTOR SURFACES

Shot Put Throwing Sector Surfaces make a firm, smooth surface with great drainage. Available in burgundy red, grey, black, white or tan with either 20% red, grey, black, white or tan **Beam Clay® Binder** for a smoother surface, or 5% red, grey, black, white or tan **Beam Clay® Binder** for a somewhat "crunchier" surface, or "**STABILIZED**" in red, grey, black, white or tan for a firmer, yet more resilient, surface – each with excellent drainage and resistance to erosion. Recommended depth is 3"-4" over a firm, well-draining base.

3/16" Shot Put Throwing Sector Surfacing with Natural Beam Clay® Binder

One cubic yard weighs approximately 2,700 lbs. in red, approximately 3,240 lbs. in grey, black, white or tan, plus add 20% for compaction. Each 1" compacted requires approximately 5 tons per 1,000 square feet in red or 6 tons per 1,000 square feet in grey, black, white or tan.

		BULK/TON		50 LB. BAG Up to 50/pallet
Burgundy Red with 5% Beam Clay® Red Binder	SP-R5 BULK	\$60	SP-R5 BAG	\$6.50
Burgundy Red with 20% Beam Clay® Red Binder	SP-R20 BULK	\$90	SP-R20-BAG	\$7.25
Grey, Black or White with 5% Beam Clay® Grey Binder	SP-(G,B, W)5-BULK	\$60	SP-(G,B, W)5 BAG	\$6.75
Grey, Black or White with 20% Beam Clay® Grey Binder	SP-(G,B, W)20-BULK	\$90	SP-(G,B, W)20 BAG	\$7.50
Tan with 5% Beam Clay® Tan Binder	SP-T5 BULK	\$80	SP-T5 BAG	\$8.00
Tan with 20% Beam Clay® Tan Binder	SP-T20 BULK	\$110	SP-T20 BAG	\$8.75

3/16" Shot Put Throwing Sector Surfacing with Stabilizer® Binder

For an even firmer yet more resilient surface with even less maintenance. One cubic yard weighs approximately 2,700 lbs. in red, approximately 3,240 lbs. in grey, black, white or tan plus add 20% for compaction. Each 1" compacted requires approximately 5 tons per 1,000 square feet in red or 6 tons per 1,000 square feet in grey, black, white or tan.

		BULK/TON		50 LB. BAG Up to 50/pallet
Burgundy Red with Stabilizer® Binder	SP-RS BULK	\$115	SP-RS BAG	\$8
Grey, Black or White with Stabilizer® Binder	SP-(G,B,W)S BULK	\$115	SP-(G,B,W)S BAG	\$8.25
Tan with Stabilizer® Binder	SP-TS BULK	\$135	SP-TS BAG	\$9.50

PALLET & COVER CHARGES: \$6.50/PALLET.

Also available:

Regional Shot Put Throwing Sector Surfacing from plants in the South, Mid-West, and West Coast.

YOUR "ONE-STOP" SOURCE FOR AMERICA'S BASEBALL, SOFTBALL & SPORTS SURFACES & SUPPLIES!

PRICES SUBJECT TO CHANGE & AVAILABILITY PLUS SHIPPING | VOLUME DISCOUNTS AVAILABLE | COOPERATIVE PURCHASING CONTRACT PRICING FOR 50 STATES

BEAM CLAY®

WHOLESALE PRICE LIST EFFECTIVE: JANUARY 1, 2021

Shots / Throwing Weights

Shots / Throwing Weights

Competition Iron Shot Puts

These iron shots are official weight and size, and are ideal for competition and practice. We offer all standard weights. Masters, Special Olympics, and overweight training shots.



TIS3	3 lbs.; Special Olympics; 71mm UPS 4 lbs.	\$23
TIS45	4 lbs.; Special Olympics; 80mm UPS 5 lbs.	\$27
TIS2	2 kilo; 88mm UPS 6 lbs.	\$26
TIS6	6 lbs.; 91mm UPS 7 lbs.	\$24
TIS3M	3 kilo women; 50+ 93mm UPS 8 lbs.	\$26
TIS8	8 lbs.; 99mm UPS 9 lbs.	\$28
TIS4	4 kilo; 104mm (orange) UPS 10 lbs.	\$32
TIS10	10 lbs.; 107mm UPS 10 lbs.	\$35
TIS5M	5 kilo men; 60+ 112mm UPS 13 lbs.	\$37
TIS12	12 lbs.; 114mm UPS 13 lbs.	\$37
TIS6M	6 kilo men; 50-59 119mm UPS 14 lbs.	\$45
TIS14	14 lbs.; 121mm UPS 15 lbs.	\$53
TIS16	16 lbs.; 126mm UPS 17 lbs.	\$53

Brass Shot Put

Lathe turned to minimum diameter allowed in competition. Machined finish gives excellent grip. Calibrated to exact weight. Quality of this shot is unsurpassed.



TB4	8 lbs. 13 oz. (4 kilo); 95mm UPS 10 lbs.	\$158
TB12	12 lbs. (5.44 kilo); 102mm UPS 13 lbs.	\$191
TB16	16 lbs. (7.25 kilo); 110mm UPS 17 lbs.	\$208

Cantabrian Steel Shots

These shots are the maximum legal diameter. Perfectly balanced for optimum flight. This shot only offered in one diameter per size. True competition shot with a lightly textured finish.

TCS129	16 lbs.; 129mm UPS 16 lbs.	\$130
TCS117	12 lbs.; 117mm UPS 12 lbs.	\$129
TCS109	4 kilo; 109mm UPS 10 lbs.	\$115

World Class Shots

These iron shots have been lathe turned to size and are perfectly round. Designed for advanced throwers, these shots give championship performance at a budget price. (Colors may vary)



TIWS100	4 kilo; 100mm UPS 10 lbs.	\$78
TIWS104	4 kilo; 104mm UPS 10 lbs.	\$64
TIWS108	4 kilo; 108mm UPS 10 lbs.	\$68
TIWS112	12 lbs.; 108mm UPS 13 lbs.	\$92
TIWS115	12 lbs.; 115mm UPS 13 lbs.	\$72
TIWS120	16 lbs.; 120mm UPS 17 lbs.	\$116
TIWS125	16 lbs.; 125mm UPS 17 lbs.	\$102
TIWS128	16 lbs.; 128mm UPS 17 lbs.	\$89



Indoor Shots - Soft Shell

These accurate weight, soft shell shots are ideal for indoor meets and practice. They will not mar floor, yet retain round shape.



TSS6	6 lbs.; 100mm UPS 7 lbs.	\$75
TSS8	8 lbs.; 113mm UPS 9 lbs.	\$85
TSS4	4 kilo; 114mm UPS 10 lbs.	\$85
TSS12	12 lbs.; 126mm UPS 13 lbs.	\$95
TSS16	16 lbs.; 138mm UPS 17 lbs.	\$125

Turned Steel Shot

The turned steel shots are for the more advanced thrower looking for a specific diameter shot for competition. These shots have been lathe turned and are balanced for the best performance. (Colors may vary)



TSS96	4 kilo; 96mm UPS 10 lbs.	\$115
TSS109	4 kilo; 109mm UPS 10 lbs.	\$119
TSS102	12 lbs.; 102mm UPS 13 lbs.	\$115
TSS110	12 lbs.; 110mm UPS 13 lbs.	\$119
TSS117	12 lbs.; 117mm UPS 13 lbs.	\$129
TSS116	16 lbs.; 110mm UPS 17 lbs.	\$119
TSS129	16 lbs.; 129mm UPS 17 lbs.	\$130

Indoor Shots - Hard Shell

These accurate weight, hard shell shots hold their round shape and are designed to be thrown onto indoor track surfaces or dirt. They are NOT recommended for wood floors.



THS6	6 lbs.; 100mm UPS 7 lbs.	\$80
THS8	8 lbs.; 113mm UPS 9 lbs.	\$87
THS4	4 kilo; 114mm UPS 10 lbs.	\$90
THS12	12 lbs.; 125mm UPS 13 lbs.	\$105
THS16	16 lbs.; 137mm UPS 17 lbs.	\$135

Stainless Steel Shots

High quality stainless steel shots are lathe turned to a perfect sphere and are designed for world class competition.



TSP4	4 kilo; 95mm UPS 10 lbs.	\$153
TSP12	12 lbs.; 103mm UPS 13 lbs.	\$180
TSP16	16 lbs.; 110mm UPS 17 lbs.	\$197

SHOT COLORS MAY VARY.
REFER TO PAGE 38 FOR SHOT SELECTION GUIDE.

YOUR "ONE-STOP" SOURCE FOR AMERICA'S BASEBALL, SOFTBALL & SPORTS SURFACES & SUPPLIES!

PRICES SUBJECT TO CHANGE & AVAILABILITY PLUS SHIPPING | VOLUME DISCOUNTS AVAILABLE | COOPERATIVE PURCHASING CONTRACT PRICING FOR 50 STATES

BEAM CLAY®

WHOLESALE PRICE LIST EFFECTIVE: JANUARY 1, 2021

Hammers

Hammers



All hammer handles conform to new IAAF rules.

Cantabrian Hammer

Minimum diameter steel hammers have perfect balance. Light textured powder coat finish. Stainless steel swivel. High quality stainless steel bearings. Comes with wire and handle.

TCSH110	110 16 lbs.; 110mm; Black UPS 17 lbs.	\$177
TCSH103	12 lbs.; 102mm; Blue UPS 13 lbs.	\$165
TCSH95	4 K; 95mm; Pink UPS 10 lbs.	\$145



Cantabrian Aluminum Hammer Handle

Machine cut from solid forged aluminum ingot helps to ensure handle never elongates or stretches. CNC cut to make for perfect fit in thrower's hand. Precise 110mm measurement from bottom of handle to center of hammer wire hole ensures consistent hammer lengths and throws. Pressed bronze bushing where wire is attached is radiused for easy swivel of wire during wind up and throws. Was used on hammer that set new record for hammer throw.



TCAHH	UPS 3 lbs.	\$69
-------	------------	------

A. Stainless Steel Hammer

Stainless steel hammer uses a high quality stainless high spin swivel and comes with 2mm wire and Olympic handle.

THSS4	4 kilo; 95mm UPS 10 lbs.	\$239
THSS12	12 lbs.; 103mm UPS 13 lbs.	\$275
THSS16	16 lbs.; 110mm UPS 17 lbs.	\$309

B. Lathe-Turned Iron Hammer

Meets all official specifications. All steel swivel, wire and competition steel handle included.

TIH4	4 kilo; 101mm UPS 10 lbs.	\$83
TIH5.5	5.5 kilo (12 lbs); 112mm UPS 13 lbs.	\$92
TIH7	16 lbs.; 124mm UPS 17 lbs.	\$99



Hammer Wires

Meets all official specifications. All steel swivel, wire and competition steel handle included.

TW1	37.5" UPS 2 lbs. each	\$16
TW2	38" UPS 2 lbs. each	\$16
TW3	38.25" UPS 2 lbs. each	\$16
TW4	38.5" UPS 2 lbs. each	\$16
TW5	39" UPS 2 lbs. each	\$16
TW5.5	39.5" UPS 2 lbs. each	\$16

Gloves-Hammer

World-famous high quality glove. Has extra wide leather piece over fingers for longer wear and safety.

TGLM	Left; medium UPS 2 lbs. each	\$40
TGLL	Left; large UPS 2 lbs. each	\$40
TGLXL	Left; x-large UPS 2 lbs. each	\$40
TGRM	Right; medium UPS 2 lbs. each	\$40
TGRL	Right; large UPS 2 lbs. each	\$40
TGRXL	Right; xlarge UPS 2 lbs. each	\$40



Distance Markers

Used for marking contestant's throws. Competitors' names and numbers can be written on marker with chalk. Durable and long-lasting.

TDM	Dozen UPS 3 lbs.	\$40
-----	------------------	------



Removable discus tray.

REFER TO PAGE 39 FOR
HAMMER SELECTION GUIDE

Multi-Use Implement Cart

The heavy duty, all steel cart will hold 8 shots, 8 discus and 8 javelins at one time. Discus tray can be lifted out of the cart and set in discus area, works great for storage and competition. Cart rides on 4 solid wheels.

TMIC	101 lbs. F Class 70	\$749
------	---------------------	-------



D. Shot & Discus Carry Bag

TCCB	Canvas UPS 2 lbs.	\$35
TVCB	Vinyl UPS 2 lbs.	\$19
TVCBS	Vinyl with Strap UPS 2 lbs.	\$21



E. Shot Carrier

Designed to carry one shot, hand tied from heavy polyethylene rope and has comfort carry handles.

TSPC	UPS 2 lbs.	\$14
------	------------	------

YOUR "ONE-STOP" SOURCE FOR AMERICA'S BASEBALL, SOFTBALL & SPORTS SURFACES & SUPPLIES!

PRICES SUBJECT TO CHANGE & AVAILABILITY PLUS SHIPPING | VOLUME DISCOUNTS AVAILABLE | COOPERATIVE PURCHASING CONTRACT PRICING FOR 50 STATES

BEAM CLAY®

High Jump / Pole Vault Accessories

WHOLESALE PRICE LIST
EFFECTIVE: JANUARY 1, 2021

Stands & Miscellaneous Accessories



A. Track Starters Stand

This all steel powder coated two-step stand will give your starter the visibility they need. Two solid wheels make this stand easy to transport.

TSSTAND F Class 250, 73 lbs

\$635

B. Track Judges Stand

- Movable stand with 8" wheels accommodates 10 judges.
- Rail support for safety.
- Red enamel finish.
- Galvanized steel seats, footrests and back support.

TTJS F Class 250, 230 lbs

\$1,295

C. Track Equipment Wagon

The perfect vehicle for hauling a variety of equipment from the storage area to the track. Fold down gates, 13" pneumatic tires, 1000 lbs. capacity. Color of cart may vary. Equipment not included.

TSEW 45" L x 26" H x 23" W UPS 80 lbs.

\$269

D. Pit Rake

Excellent heavy duty aluminum rake for raking and smoothing landing pits and baseball infields. One side has long, sturdy teeth and the other side has flat edge for leveling.

TGR24 24" pit rake UPS 5 lbs. Ships Dimensional

\$69

TGR 36" infield rake UPS 6 lbs. Ships Dimensional

\$80

F. Plastic Flag Ropes

Colorful pennants ideal for cross-country chutes and roping off restricted areas for crowd control. 100 ft. in length. Stock color is red, white and blue. .

FPFR Custom colors available; additional \$10.00 fee applies. UPS 2 lbs

\$32

G. Boundary Cones

Heavy duty cones have weighted bases and have hundreds of uses for drills, cross country courses, gym activities, or establishing temporary zones.

FBC12 12" heavy cones UPS 2 lbs.

\$18

FBC18 18" heavy cones UPS 4 lbs.

\$19

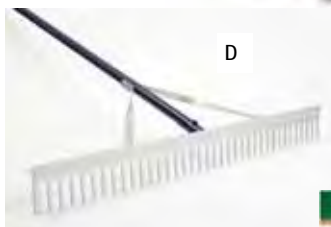

YOUR "ONE-STOP" SOURCE FOR AMERICA'S BASEBALL, SOFTBALL & SPORTS SURFACES & SUPPLIES!

PRICES SUBJECT TO CHANGE & AVAILABILITY PLUS SHIPPING | VOLUME DISCOUNTS AVAILABLE | COOPERATIVE PURCHASING CONTRACT PRICING FOR 50 STATES

PARTAC PEAT CORPORATION
ONE KELSEY PARK, GREAT MEADOWS, NEW JERSEY 07838

800-247-BEAM (2326) • (908) 637-4191 • FAX (908) 637-8421
www.beamclay.com • sales@beamclay.com
Bid Term - 5/9/18 - 5/8/20; Extended to 5/8/21; Extended to 5/8/22

BEAM CLAY®

WHOLESALE PRICE LIST EFFECTIVE: JANUARY 1, 2021

High Jump / Pole Vault Accessories

A. Lap Counter with Bell

This lap counter is made with an aluminum frame and plated steel base. Wheels on base make for easy transportation. Swivel top allows numbers to be rotated around for full viewing. Unit comes with 2-10" flip indicators. Each indicator contains 10 numbers from 0-9. Indicators have side flip lever for quick easy number changes. Comes with loud brass bell to indicate last lap.

TLC UPS 3 pkgs (1) at 11 lbs., (1) at 17 lbs., (1) at 3 lbs. + AH **\$455**

B. Performance Indicators

This performance indicator is made with an aluminum frame and plated steel base. Wheels on base make for easy transportation. Swivel top allows numbers to be rotated around for full viewing. Unit comes with 4 or 5-10" flip indicators. Each indicator contains 10 numbers from 0-9. Indicators have side flip lever for quick easy number changes.

TEPI-4 4 digit event performance indicator **\$565**
 UPS 3 pkgs (1) at 21 lbs., (1) at 26 lbs., (1) at 5 lbs. + AH

TEPI-5 5 digit event performance indicator **\$595**
 UPS 3 pkgs (1) at 24 lbs., (1) at 26 lbs., (1) at 5 lbs. + AH

C. Replacement Digital Numbers

Can be used for both the "TLC" lap counter and "TEPI" indicators as replacement numbers. Will also fit similar units using same sizes. (13 1/4" x 7 1/2" x 1 1/16").

TDI Black UPS 3 lbs. **\$98**

TDIR Red UPS 3 lbs. **\$98**

D. Wind Gauge

Has following features: Current maximum wind speed. Average wind speed over 5, 10, or 13 seconds. Choose from any measurement unit. Reads in tenths. Current temperature and wind chill. Replaceable 400 hour lithium battery. Data lock feature. Replaceable plastic impeller will not corrode. Comes with lanyard. Threaded for tripod mounting. Adjustable tripod. Accuracy is +/- 1%, when aligned with wind's axis.

TWG UPS 7 lbs. **\$439**

E. Track & Field Score Book

Scores 19 meets. Up to 8 places can be scored. Time, height, or distance can be recorded for all places. Can be used for duals of up to five teams. Room to score 14 individual events and 3 relays. Illustrated sample score sheet.

TSB UPS 1 lb. **\$15**

F. Digital Implement Scale

This scale is perfect for use at meets where you want an accurate scale that will weigh up to the largest implements. Scale is accurate to 0.1 ounce and has a 55 lb. capacity. Easy read digital scale is powered by 4 "C" cell batteries (not included). Also includes an AC Adapter. Detachable faceplate, too many functions to list.

TDIS UPS 9 lbs. **\$132**

G. Ultrak Scoreboard/Display

Radio frequency remote control scoreboard, controllable and viewable from 150 feet away. 4" LCD digits. 20" wide by 30" high. Runs on four D cell batteries (not included) - no cords required. Programmable count-up/down game time with range to 9 hrs., 59 min., 59 sec. Four inch LCD digits display scores for two teams up to 199. Competitor and attempt numbers can be changed to home and guest numbers for court event scoreboard. Free standing on floor; table or wall-mounted.

TSWScore UPS 22 lbs. Ships Dimensional **\$875**

H. Ultrak T-100 Display/Race Clock

Radio frequency remote control display timer is controllable and viewable from 150 feet away. 4" LCD digits. 20" wide by 12" high. Runs on four D cell batteries (not included) - no cords required. Timer is programmable for count-up/down game or event time with range to 9 hrs., 59 min., 59 sec. with four-inch LCD digits. Free standing on floor; table or wall-mounted.

TSWT100 UPS 10 lbs. **\$659**



YOUR "ONE-STOP" SOURCE FOR AMERICA'S BASEBALL, SOFTBALL & SPORTS SURFACES & SUPPLIES!

PRICES SUBJECT TO CHANGE & AVAILABILITY PLUS SHIPPING | VOLUME DISCOUNTS AVAILABLE | COOPERATIVE PURCHASING CONTRACT PRICING FOR 50 STATES

BEAM CLAY®

WHOLESALE PRICE LIST EFFECTIVE: JANUARY 1, 2021

Discus Cage & Rings

Discus Cage & Rings



*Freight offer valid in lower 48 U.S. states only.

Cantabrian Aluminum Discus Cage

- Sets up in less than 15 minutes.
- Premium quality cantilevered 2 7/8" aluminum poles. 16' height.
- 2' sleeve.
- 14' net height.
- Angled poles for added safety.
- Heavy duty 14' x 58' UV 3mm weather resistant net.
- Easily raised and lowered.
- Product comes with spectator warning signs.
- Exceeds NFHS specifications.
- Stackhouse Discus Cage conforms to the 34.92" throwing sector rule.

Sector Line Tape With Reel

- 3" wide, double-coated vinyl material
- 330' in length
- Plastic reel included for easy use and storage

SLT

\$265



High School Aluminum Discus cage		
THCSA-14	F Class 70, 6pcs, 285lbs	\$2,775
Replacement net for THCSA-14		
THCSA14x58	UPS 31lbs. Ships Dimensional	\$1,365
Replacement sleeve only for THCSA-14		
THCSASL	UPS 1lbs ea	\$55
13' 4" height with (6) square steel, white powder coated poles		
THSCAN14	F Class 70, 350 lbs, Call for Freight Quote	\$2,815
Replacement net for THSCAN14 (14' x 55')		
TDC14X55RPL	UPS 31 lbs. Ships Dimensional	\$855
Replacement sleeve only for THSCAN14 (1 ea.)		
THSCAN14SL	UPS 13 lbs.	\$50

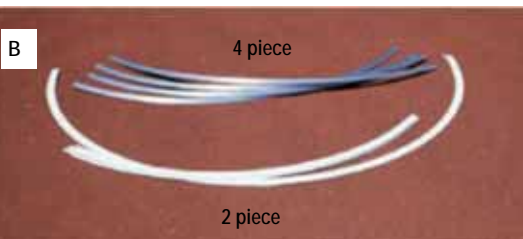

A. Webbed Discus Ring

This discus ring is manufactured in two half circles and uses 1/4" x 3" strip with welded cross braces for added rigidity and ease of installation. Two half circles are bolted together before installation ensuring circle stays round.

TCDWEB	F Class 70, 85 lb	\$789
---------------	-------------------	-------

Webbed Shot/Hammer Ring

This shot/hammer ring is manufactured in two half circles and uses a 1/4" x 3" strip with welded cross braces for added rigidity and ease of installation. Two half circles are bolted together before installation ensuring circle stays round.

TCSHWEB	F Class 70, 67 lbs	\$765
----------------	--------------------	-------

B. Official Circles

Aluminum angle constructed ring. Made of 1" x 3/4" x 1/4" aluminum. Comes in 4 sections with anchoring holes.

TADR	4 pc. discus ring UPS 10 lbs. Ships Dimensional	\$230
-------------	---	-------

TASR	4 pc. shot ring UPS 10 lbs. Ships Dimensional	\$230
-------------	---	-------

2-piece design that hinges in center for economical UPS shipping. Made of 1/4" x 1 1/2" steel. Can be screwed or bolted down.

T2PCD	2 pc. discus ring UPS 36 lbs. Ships Dimensional	\$295
--------------	---	-------

T2PCS	2 pc. shot ring UPS 28 lbs. Ships Dimensional	\$259
--------------	---	-------

C. Sector Guide

This sector guide allows you to correctly lay out your throwing zone in a matter of minutes. Comes with an all-weather vinyl template and instructions. Template marked for shot, discus, javelin and hammer.

TSG	UPS 6 lbs	\$102
------------	-----------	-------

D



D. Sector Line Marking Tape

Line your throwing area in minutes with this easy to see sector tape. Comes in 2" x 130 yd. rolls.

TSTW	White UPS 6 lbs.	\$49
TSTO	Orange UPS 6 lbs.	\$49
TSTS	Spool for sector tape UPS 5 lbs.	\$27
TGS	Ground staples for tape. Pack of 10 UPS 3 lbs. (on average, one every 10')	\$18

YOUR "ONE-STOP" SOURCE FOR AMERICA'S BASEBALL, SOFTBALL & SPORTS SURFACES & SUPPLIES!

PRICES SUBJECT TO CHANGE & AVAILABILITY PLUS SHIPPING | VOLUME DISCOUNTS AVAILABLE | COOPERATIVE PURCHASING CONTRACT PRICING FOR 50 STATES

BEAM CLAY®

WHOLESALE PRICE LIST
 EFFECTIVE: JULY 1, 2021

Portable Discus Cage & Throwing Platform

Portable Discus Cage



Completely welded base support (no caps) with internal weight stability.

Reinforced support bracing keeps the portable frame rigid under normal use.



Premier Outdoor Throwing Platform

Portable Discus Cage #HSDC-P / #CDC-P

When your throwers need to relocate from time to time, this portable discus cage puts safety on the move. Precisely angled brackets, combined with exact length weighted support braces, allow for a repeatable cage assembly adds stability and eliminates human error.

- All-aluminum posts (4"OD) feature 3' offset to prevent implement deflection - 14'H for HS/17'H for NCAA
- Weather-treated nylon main safety net (14'H for HS/17'H for NCAA) can be set up and taken down with a simple pulley system
- Offset eye-bolts secure bottom of net to base
- Included backup net (7') keeps onlookers at a safer distance from main safety net
- Meet all NFHS/NCAA rules and regulations
- See drawings for specifications, installation instructions and plan/layout recommendations
- Proudly Made in the USA

Premier Outdoor Throwing Platform #POP

This is a versatile outdoor platform designed to be used in conjunction with our Portable Discus Cage.

- Versatile outdoor platform designed to be used in conjunction with our Portable Discus Cage
- Nominal Size 9'W x 9'L x 3"H
- Two identical panels, with recessed handles for lifting, bolt together during use via an internal mate, which allows for a seamless alignment and tight fit
- Each panel features a three-layer construction: a structural aluminum inner core; a 3/4" thick grade A plywood surface (chamfered at the seam); and a synthetic rubber top to allow for minimal friction
- Retractable stainless steel handles are ergonomically designed to allow for quick and easy moving of platform
- Add our Model No. HDR-S Conversion Ring and Model No. STBC Toe Board and your ready for the Shot Event
- Proudly Made in the USA

Vinyl Sandbags

- Fabricated with 18 oz. vinyl panels measuring 18" x 18" with heavy gauge zipper
- Heavy duty canvas handles attached via Box-X stitch method
- Yellow is standard - also available in white

#VSZ

Vinyl Sandbags

\$75



Base Weights (80 lbs.)

- Adds further stability to portable products in a more seamless fashion
- Aluminum construction guarantees no rusting
- Optional 3" or 5" wide welded channel to fit

#BW-80

Base Weights

\$625

#HSDC-P	High School Portable Discus Cage	\$13,775
#CDC-P	Collegiate Portable Discus Cage	\$18,895
#POP	Premier Outdoor Throwing Platform	\$8,495

YOUR "ONE-STOP" SOURCE FOR AMERICA'S BASEBALL, SOFTBALL & SPORTS SURFACES & SUPPLIES!

PRICES SUBJECT TO CHANGE & AVAILABILITY PLUS SHIPPING | VOLUME DISCOUNTS AVAILABLE | COOPERATIVE PURCHASING CONTRACT PRICING FOR 50 STATES

Partac Peat Corporation – Item Price Schedule													
Athletic Equipment & Supplies BID# ESCNJ 17/18-31 Effective 5/9/2018 - 5/8/2022													
Bidding Company Name:				Partac Peat Corporation		Catalog Name:		9 - Running Tracks / Shot Put Sector Surfacing / Long Jump Pits					
No.	Product Category	Beam Clay Catalog Section #	Page#	Product Description	Manufacturer	Vendor SKU	Unit of Measure	Catalog List Price	Bid Discount Percentage	Discount Amt.	Net Effective Bid Price	Comments	No.
1	Track & Field	9	2	Jet Track Running Track Mix - 3/16" Burgundy Red with 5% Beam Clay Red Binder - BULK #JT-R5 BULK	Partac Peat Corporation	JT-R5 BULK	TON	\$ 60.000	5.0%	\$ 3.000	\$ 57.000	+ shipping - see freight notes	1
2	Track & Field	9	2	Jet Track Running Track Mix - 3/16" Burgundy Red with 5% Beam Clay Red Binder - 50 LB. BAG #JT-R5 BAG	Partac Peat Corporation	JT-R5 BAG	50 LB BAG	\$ 6.500	5.0%	\$ 0.325	\$ 6.175	+ shipping - see freight notes	2
3	Track & Field	9	2	Jet Track Running Track Mix - 3/16" Burgundy Red with 20% Beam Clay Red Binder - BULK #JT-R20 BULK	Partac Peat Corporation	JT-R20 BULK	TON	\$ 90.000	5.0%	\$ 4.500	\$ 85.500	+ shipping - see freight notes	3
4	Track & Field	9	2	Jet Track Running Track Mix - 3/16" Burgundy Red with 20% Beam Clay Red Binder - 50 LB. BAG #JT-R20 BAG	Partac Peat Corporation	JT-R20 BAG	50 LB BAG	\$ 7.250	5.0%	\$ 0.363	\$ 6.888	+ shipping - see freight notes	4
5	Track & Field	9	2	Jet Track Running Track Mix - 3/16" Grey with 5% Beam Clay Grey Binder - BULK #JT-G5 BULK	Partac Peat Corporation	JT-G5-BULK	TON	\$ 60.000	5.0%	\$ 3.000	\$ 57.000	+ shipping - see freight notes	5
6	Track & Field	9	2	Jet Track Running Track Mix - 3/16" Grey with 5% Beam Clay Grey Binder - 50 LB. BAG #JT-G5 BAG	Partac Peat Corporation	JT-G5 BAG	50 LB BAG	\$ 6.750	5.0%	\$ 0.338	\$ 6.413	+ shipping - see freight notes	6
7	Track & Field	9	2	Jet Track Running Track Mix - 3/16" Grey with 20% Beam Clay Grey Binder - BULK - #JT-G20 BULK	Partac Peat Corporation	JT-G20 BULK	TON	\$ 90.000	5.0%	\$ 4.500	\$ 85.500	+ shipping - see freight notes	7
8	Track & Field	9	2	Jet Track Running Track Mix - 3/16" Grey with 20% Beam Clay Grey Binder - 50 LB. BAG #JT-G20 BAG	Partac Peat Corporation	JT-G20 BAG	50 LB BAG	\$ 7.500	5.0%	\$ 0.375	\$ 7.125	+ shipping - see freight notes	8
9	Track & Field	9	2	Jet Track Running Track Mix - 3/16" Black with 5% Beam Clay Black Binder - BULK #JT-B5 BULK	Partac Peat Corporation	JT-B5-BULK	TON	\$ 60.000	5.0%	\$ 3.000	\$ 57.000	+ shipping - see freight notes	9
10	Track & Field	9	2	Jet Track Running Track Mix - 3/16" Black with 5% Beam Clay Black Binder - 50 LB. BAG #JT-B5 BAG	Partac Peat Corporation	JT-B5 BAG	50 LB BAG	\$ 6.750	5.0%	\$ 0.338	\$ 6.413	+ shipping - see freight notes	10
11	Track & Field	9	2	Jet Track Running Track Mix - 3/16" Black with 20% Beam Clay Black Binder - BULK - #JT-B20 BULK	Partac Peat Corporation	JT-B20 BULK	TON	\$ 90.000	5.0%	\$ 4.500	\$ 85.500	+ shipping - see freight notes	11
12	Track & Field	9	2	Jet Track Running Track Mix - 3/16" Black with 20% Beam Clay Black Binder - 50 LB. BAG #JT-B20 BAG	Partac Peat Corporation	JT-B20 BAG	50 LB BAG	\$ 7.500	5.0%	\$ 0.375	\$ 7.125	+ shipping - see freight notes	12
13	Track & Field	9	2	Jet Track Running Track Mix - 3/16" White with 5% Beam Clay White Binder - BULK #JT-W5 BULK	Partac Peat Corporation	JT-W5-BULK	TON	\$ 60.000	5.0%	\$ 3.000	\$ 57.000	+ shipping - see freight notes	13
14	Track & Field	9	2	Jet Track Running Track Mix - 3/16" White with 5% Beam Clay White Binder - 50 LB. BAG #JT-W5 BAG	Partac Peat Corporation	JT-W5 BAG	50 LB BAG	\$ 6.750	5.0%	\$ 0.338	\$ 6.413	+ shipping - see freight notes	14
15	Track & Field	9	2	Jet Track Running Track Mix - 3/16" White with 20% Beam Clay White Binder - BULK - #JT-W20 BULK	Partac Peat Corporation	JT-W20 BULK	TON	\$ 90.000	5.0%	\$ 4.500	\$ 85.500	+ shipping - see freight notes	15
16	Track & Field	9	2	Jet Track Running Track Mix - 3/16" White with 20% Beam Clay White Binder - 50 LB. BAG #JT-W20 BAG	Partac Peat Corporation	JT-W20 BAG	50 LB BAG	\$ 7.500	5.0%	\$ 0.375	\$ 7.125	+ shipping - see freight notes	16
17	Track & Field	9	2	Jet Track Running Track Mix - 3/16" Tan with 5% Beam Clay Tan Binder - BULK #JT-T5 BULK	Partac Peat Corporation	JT-T5 BULK	TON	\$ 80.000	5.0%	\$ 4.000	\$ 76.000	+ shipping - see freight notes	17
18	Track & Field	9	2	Jet Track Running Track Mix - 3/16" Tan with 5% Beam Clay Tan Binder - 50 LB. BAG # JT-T5 BAG	Partac Peat Corporation	JT-T5 BAG	50 LB BAG	\$ 8.000	5.0%	\$ 0.400	\$ 7.600	+ shipping - see freight notes	18
19	Track & Field	9	2	Jet Track Running Track Mix - 3/16" Tan with 20% Beam Clay Tan Binder - BULK #JT-T20 BULK	Partac Peat Corporation	JT-T20 BULK	TON	\$ 110.000	5.0%	\$ 5.500	\$ 104.500	+ shipping - see freight notes	19
20	Track & Field	9	2	Jet Track Running Track Mix - 3/16" Tan with 20% Beam Clay Tan Binder - 50 LB. BAG # JT-T20 BAG	Partac Peat Corporation	JT-T20 BAG	50 LB BAG	\$ 8.750	5.0%	\$ 0.438	\$ 8.313	+ shipping - see freight notes	20
21	Track & Field	9	2	Jet Track Running Track Mix - 3/16" Burgundy Red with Stabilizer Binder - BULK - #JT-RS BULK	Partac Peat Corporation	JT-RS BULK	TON	\$ 115.000	5.0%	\$ 5.750	\$ 109.250	+ shipping - see freight notes	21
22	Track & Field	9	2	Jet Track Running Track Mix - 3/16" Burgundy Red with Stabilizer Binder - 50 LB. BAG - # JT-RS BAG	Partac Peat Corporation	JT-RS BAG	50 LB BAG	\$ 8.000	5.0%	\$ 0.400	\$ 7.600	+ shipping - see freight notes	22
23	Track & Field	9	2	Jet Track Running Track Mix - 3/16" Grey with Stabilizer Binder - BULK - # JT-GS BULK	Partac Peat Corporation	JT-GS BULK	TON	\$ 115.000	5.0%	\$ 5.750	\$ 109.250	+ shipping - see freight notes	23
24	Track & Field	9	2	Jet Track Running Track Mix - 3/16" Grey with Stabilizer Binder - 50 LB. BAG - # JT-GS BAG	Partac Peat Corporation	JT-GS BAG	50 LB BAG	\$ 8.250	5.0%	\$ 0.413	\$ 7.838	+ shipping - see freight notes	24

Bidding Company Name:				Partac Peat Corporation	Catalog Name:		9 - Running Tracks / Shot Put Sector Surfacing / Long Jump Pits						
No.	Product Category	Beam Clay Catalog Section #	Page#	Product Description	Manufacturer	Vendor SKU	Unit of Measure	Catalog List Price	Bid Discount Percentage	Discount Amt.	Net Effective Bid Price	Comments	No.
25	Track & Field	9	2	Jet Track Running Track Mix - 3/16" Black with Stabilizer Binder - BULK -# JT-BS BULK	Partac Peat Corporation	JT-BS BULK	TON	\$ 115.000	5.0%	\$ 5.750	\$ 109.250	+ shipping - see freight notes	25
26	Track & Field	9	2	Jet Track Running Track Mix - 3/16" Black with Stabilizer Binder - 50 LB. BAG -# JT-BS BAG	Partac Peat Corporation	JT-BS BAG	50 LB BAG	\$ 8.250	5.0%	\$ 0.413	\$ 7.838	+ shipping - see freight notes	26
27	Track & Field	9	2	Jet Track Running Track Mix - 3/16" White with Stabilizer Binder - BULK -# JT-WS BULK	Partac Peat Corporation	JT-WS BULK	TON	\$ 115.000	5.0%	\$ 5.750	\$ 109.250	+ shipping - see freight notes	27
28	Track & Field	9	2	Jet Track Running Track Mix - 3/16" White with Stabilizer Binder - 50 LB. BAG -# JT-WS BAG	Partac Peat Corporation	JT-WS BAG	50 LB BAG	\$ 8.250	5.0%	\$ 0.413	\$ 7.838	+ shipping - see freight notes	28
29	Track & Field	9	2	Jet Track Running Track Mix - 3/16" Tan with Stabilizer Binder - BULK -#JT-TS BULK	Partac Peat Corporation	JT-TS BULK	TON	\$ 135.000	5.0%	\$ 6.750	\$ 128.250	+ shipping - see freight notes	29
30	Track & Field	9	2	Jet Track Running Track Mix - 3/16" Tan with Stabilizer Binder - 50 LB. BAG -# JT-TS BAG	Partac Peat Corporation	JT-TS BAG	50 LB BAG	\$ 9.500	5.0%	\$ 0.475	\$ 9.025	+ shipping - see freight notes	30
31	Track & Field	9	3	Running Track Rubber Curbing - 4" High x 4" Wide x 6' Long #RC-4x4x6	RubbeRecycle	RC-4x4x6	PIECE	\$ 35.000	5.0%	\$ 1.750	\$ 33.250	+ shipping - see freight notes	31
32	Track & Field	9	3	Running Track Rubber Curbing - 6" High x 4" Wide x 6' Long #RC-6x4x6	RubbeRecycle	RC-6x4x6	PIECE	\$ 65.000	5.0%	\$ 3.250	\$ 61.750	+ shipping - see freight notes	32
33	Track & Field	9	3	Running Track Rubber Curbing - 8" High x 4" Wide x 6' Long #RC-8x4x6	RubbeRecycle	RC-8x4x6	PIECE	\$ 82.000	5.0%	\$ 4.100	\$ 77.900	+ shipping - see freight notes	33
34	Track & Field	9	3	Running Track Rubber Curbing - 4" High x 3" Wide x 6' Long #RC-4x3x6	RubbeRecycle	RC-4x3x6	PIECE	\$ 36.000	5.0%	\$ 1.800	\$ 34.200	+ shipping - see freight notes	34
35	Track & Field	9	3	Running Track Rubber Curbing - 4" High x 3" Wide x 4' Long #RC-4x3x4	RubbeRecycle	RC-4x3x4	PIECE	\$ 20.000	5.0%	\$ 1.000	\$ 19.000	+ shipping - see freight notes	35
36	Track & Field	9	6	Outdoor Track Aluminum Curbing	AAE	#3AC	LF	\$ 17.250	5.0%	\$ 0.863	\$ 16.388	+ shipping - see freight notes	36
37	Track & Field	9	6	Outdoor Track Aluminum Curbing - Silver Anodized	AAE	#3AC-SA	LF	\$ 22.000	5.0%	\$ 1.100	\$ 20.900	+ shipping - see freight notes	37
38	Track & Field	9	6	Running Track Aluminum Curbing - #5AC	AAE	#5AC	LF	\$ 24.000	5.0%	\$ 1.200	\$ 22.800	+ shipping - see freight notes	38
39	Track & Field	9	6	Roll Out Runway - 32" Wide	Stackhouse	TR32	LF	\$ 12.000	5.0%	\$ 0.600	\$ 11.400	+ shipping - see freight notes	39
40	Track & Field	9	6	Roll Out Runway - 36" Wide	Stackhouse	TR36	LF	\$ 12.500	5.0%	\$ 0.625	\$ 11.875	+ shipping - see freight notes	40
41	Track & Field	9	6	Roll Out Runway - 42" Wide	Stackhouse	TR42	LF	\$ 12.000	5.0%	\$ 0.600	\$ 11.400	+ shipping - see freight notes	41
42	Track & Field	9	6	Roll Out Runway - 48" Wide	Stackhouse	TR48	LF	\$ 14.000	5.0%	\$ 0.700	\$ 13.300	+ shipping - see freight notes	42
43	Track & Field	9	7	Multiple Lane Dry Chalk Track Marker - 7 hopper 8 lane #LMLD-440-8	Stackhouse	LMLD-440-8	EACH	\$ 3,395.000	5.0%	\$ 169.750	\$ 3,225.250	+ shipping - see freight notes	43
44	Track & Field	9	7	Multiple Lane Dry Chalk Track Marker - 6 hopper 7 lane #LMLD-440-7	Stackhouse	LMLD-440-7	EACH	\$ 3,050.000	5.0%	\$ 152.500	\$ 2,897.500	+ shipping - see freight notes	44
45	Track & Field	9	7	Multiple Lane Dry Chalk Track Marker - 5 hopper 6 lane #LMLD-440-6	Stackhouse	LMLD-440-6	EACH	\$ 2,695.000	5.0%	\$ 134.750	\$ 2,560.250	+ shipping - see freight notes	45
46	Track & Field	9	7	Multiple Lane Dry Chalk Track Marker - 4 hopper 5 lane #LMLD-440-5	Stackhouse	LMLD-440-5	EACH	\$ 2,350.000	5.0%	\$ 117.500	\$ 2,232.500	+ shipping - see freight notes	46
47	Track & Field	9	7	Multiple Lane Dry Chalk Track Marker - 3 hopper 4 lane #LMLD-440-4	Stackhouse	LMLD-440-4	EACH	\$ 1,995.000	5.0%	\$ 99.750	\$ 1,895.250	+ shipping - see freight notes	47
48	Track & Field	9	7	Multiple Lane Dry Chalk Track Marker - replacement hopper #LMLD-440-EXT	Stackhouse	LMLD-440-EXT	EACH	\$ 350.000	5.0%	\$ 17.500	\$ 332.500	+ shipping - see freight notes	48
49	Track & Field	9	7	Multiple Lane Dry Chalk Track Marker - replacement hopper #LMLD-MAIN	Stackhouse	LMLD-MAIN	EACH	\$ 995.000	5.0%	\$ 49.750	\$ 945.250	+ shipping - see freight notes	49

Bidding Company Name:				Partac Peat Corporation	Catalog Name:		9 - Running Tracks / Shot Put Sector Surfacing / Long Jump Pits						
No.	Product Category	Beam Clay Catalog Section #	Page#	Product Description	Manufacturer	Vendor SKU	Unit of Measure	Catalog List Price	Bid Discount Percentage	Discount Amt.	Net Effective Bid Price	Comments	No.
50	Track & Field	9	8	Blanket Style Weighted Track Protectors - non-woven polypropylene, heat tempered, heather color, hemmed, binding available in 14 colors 15 oz. 7' x 30'	Humphreys	WTP-BS-7X30	EACH	\$ 540.000	5.0%	\$ 27.000	\$ 513.000	+ shipping - see freight notes	50
51	Track & Field	9	8	Blanket Style Weighted Track Protectors - non-woven polypropylene, heat tempered, heather color, hemmed, binding available in 14 colors 15 oz. 7' x 40'	Humphreys	WTP-BS-7X40	EACH	\$ 645.000	5.0%	\$ 32.250	\$ 612.750	+ shipping - see freight notes	51
52	Track & Field	9	8	Blanket Style Weighted Track Protectors - non-woven polypropylene, heat tempered, heather color, hemmed, binding available in 14 colors 15 oz. 7' x 50'	Humphreys	WTP-BS-7X50	EACH	\$ 760.000	5.0%	\$ 38.000	\$ 722.000	+ shipping - see freight notes	52
53	Track & Field	9	8	Blanket Style Weighted Track Protectors - non-woven polypropylene, heat tempered, heather color, hemmed, binding available in 14 colors 15 oz. 14' x 30'	Humphreys	WTP-BS-14X30	EACH	\$ 730.000	5.0%	\$ 36.500	\$ 693.500	+ shipping - see freight notes	53
54	Track & Field	9	8	Blanket Style Weighted Track Protectors - non-woven polypropylene, heat tempered, heather color, hemmed, binding available in 14 colors 15 oz. 14' x 40'	Humphreys	WTP-BS-14X40	EACH	\$ 865.000	5.0%	\$ 43.250	\$ 821.750	+ shipping - see freight notes	54
55	Track & Field	9	8	Blanket Style Weighted Track Protectors - non-woven polypropylene, heat tempered, heather color, hemmed, binding available in 14 colors 15 oz. 14' x 50'	Humphreys	WTP-BS-14X50	EACH	\$ 1,075.000	5.0%	\$ 53.750	\$ 1,021.250	+ shipping - see freight notes	55
56	Track & Field	9	8	Blanket Style Weighted Track Protectors - non-woven polypropylene, heat tempered, heather color, hemmed, binding available in 14 colors 15 oz. 14' x 75'	Humphreys	WTP-BS-14X75	EACH	\$ 1,450.000	5.0%	\$ 72.500	\$ 1,377.500	+ shipping - see freight notes	56
57	Track & Field	9	8	Blanket Style Weighted Track Protectors - non-woven polypropylene, heat tempered, heather color, hemmed, binding available in 14 colors 15 oz. 14' x 100'	Humphreys	WTP-BS-14X100	EACH	\$ 1,840.000	5.0%	\$ 92.000	\$ 1,748.000	+ shipping - see freight notes	57
58	Track & Field	9	8	Blanket Style Weighted Track Protectors - non-woven polypropylene, heat tempered, heather color, hemmed, binding available in 14 colors 15 oz. 14' x 125'	Humphreys	WTP-BS-14X125	EACH	\$ 2,260.000	5.0%	\$ 113.000	\$ 2,147.000	+ shipping - see freight notes	58
59	Track & Field	9	8	Blanket Style Weighted Track Protectors - non-woven polypropylene, heat tempered, heather color, hemmed, binding available in 14 colors 15 oz. 14' x 150'	Humphreys	WTP-BS-14X150	EACH	\$ 2,575.000	5.0%	\$ 128.750	\$ 2,446.250	+ shipping - see freight notes	59
60	Track & Field	9	9	ARMOR MESH WEIGHTED TRACK PROTECTORS - Heavy duty 14 oz. vinyl coated woven polyester 6' x 30' - Colors: Dark Green, Royal Blue, Red, Light Gray, Kelly Green, Maroon, Navy Blue, Black, Purple, Orange, Carolina Blue, Yellow, White	Humphreys	AM-WTP-6X30	EACH	\$ 430.000	5.0%	\$ 21.500	\$ 408.500	+ shipping - see freight notes	60
61	Track & Field	9	9	ARMOR MESH WEIGHTED TRACK PROTECTORS - Heavy duty 14 oz. vinyl coated woven polyester 6' x 40' - Colors: Dark Green, Royal Blue, Red, Light Gray, Kelly Green, Maroon, Navy Blue, Black, Purple, Orange, Carolina Blue, Yellow, White	Humphreys	AM-WTP-6X40	EACH	\$ 520.000	5.0%	\$ 26.000	\$ 494.000	+ shipping - see freight notes	61
62	Track & Field	9	9	ARMOR MESH WEIGHTED TRACK PROTECTORS - Heavy duty 14 oz. vinyl coated woven polyester 6' x 50' - Colors: Dark Green, Royal Blue, Red, Light Gray, Kelly Green, Maroon, Navy Blue, Black, Purple, Orange, Carolina Blue, Yellow, White	Humphreys	AM-WTP-6X50	EACH	\$ 590.000	5.0%	\$ 29.500	\$ 560.500	+ shipping - see freight notes	62
63	Track & Field	9	9	ARMOR MESH WEIGHTED TRACK PROTECTORS - Heavy duty 14 oz. vinyl coated woven polyester 12' x 30' - Colors: Dark Green, Royal Blue, Red, Light Gray, Kelly Green, Maroon, Navy Blue, Black, Purple, Orange, Carolina Blue, Yellow, White	Humphreys	AM-WTP-12X30	EACH	\$ 565.000	5.0%	\$ 28.250	\$ 536.750	+ shipping - see freight notes	63
64	Track & Field	9	9	ARMOR MESH WEIGHTED TRACK PROTECTORS - Heavy duty 14 oz. vinyl coated woven polyester 12' x 40' - Colors: Dark Green, Royal Blue, Red, Light Gray, Kelly Green, Maroon, Navy Blue, Black, Purple, Orange, Carolina Blue, Yellow, White	Humphreys	AM-WTP-12X40	EACH	\$ 750.000	5.0%	\$ 37.500	\$ 712.500	+ shipping - see freight notes	64
65	Track & Field	9	9	ARMOR MESH WEIGHTED TRACK PROTECTORS - Heavy duty 14 oz. vinyl coated woven polyester 12' x 50' - Colors: Dark Green, Royal Blue, Red, Light Gray, Kelly Green, Maroon, Navy Blue, Black, Purple, Orange, Carolina Blue, Yellow, White	Humphreys	AM-WTP-12X50	EACH	\$ 920.000	5.0%	\$ 46.000	\$ 874.000	+ shipping - see freight notes	65
66	Track & Field	9	9	ARMOR MESH WEIGHTED TRACK PROTECTORS - Heavy duty 14 oz. vinyl coated woven polyester 15' x 30' - Colors: Dark Green, Royal Blue, Red, Light Gray, Kelly Green, Maroon, Navy Blue, Black, Purple, Orange, Carolina Blue, Yellow, White	Humphreys	AM-WTP-15X30	EACH	\$ 705.000	5.0%	\$ 35.250	\$ 669.750	+ shipping - see freight notes	66
67	Track & Field	9	9	ARMOR MESH WEIGHTED TRACK PROTECTORS - Heavy duty 14 oz. vinyl coated woven polyester 15' x 40' - Colors: Dark Green, Royal Blue, Red, Light Gray, Kelly Green, Maroon, Navy Blue, Black, Purple, Orange, Carolina Blue, Yellow, White	Humphreys	AM-WTP-15X40	EACH	\$ 925.000	5.0%	\$ 46.250	\$ 878.750	+ shipping - see freight notes	67
68	Track & Field	9	9	ARMOR MESH WEIGHTED TRACK PROTECTORS - Heavy duty 14 oz. vinyl coated woven polyester 15' x 50' - Colors: Dark Green, Royal Blue, Red, Light Gray, Kelly Green, Maroon, Navy Blue, Black, Purple, Orange, Carolina Blue, Yellow, White	Humphreys	AM-WTP-15X50	EACH	\$ 1,160.000	5.0%	\$ 58.000	\$ 1,102.000	+ shipping - see freight notes	68
69	Track & Field	9	9	ARMOR MESH WEIGHTED TRACK PROTECTORS - Heavy duty 14 oz. vinyl coated woven polyester 15' x 75' - Colors: Dark Green, Royal Blue, Red, Light Gray, Kelly Green, Maroon, Navy Blue, Black, Purple, Orange, Carolina Blue, Yellow, White	Humphreys	AM-WTP-15X75	EACH	\$ 1,655.000	5.0%	\$ 82.750	\$ 1,572.250	+ shipping - see freight notes	69
70	Track & Field	9	9	ARMOR MESH WEIGHTED TRACK PROTECTORS - Heavy duty 14 oz. vinyl coated woven polyester 15' x 100' - Colors: Dark Green, Royal Blue, Red, Light Gray, Kelly Green, Maroon, Navy Blue, Black, Purple, Orange, Carolina Blue, Yellow, White	Humphreys	AM-WTP-15X100	EACH	\$ 2,135.000	5.0%	\$ 106.750	\$ 2,028.250	+ shipping - see freight notes	70
71	Track & Field	9	9	ARMOR MESH WEIGHTED TRACK PROTECTORS - Heavy duty 14 oz. vinyl coated woven polyester 15' x 100' - Colors: Dark Green, Royal Blue, Red, Light Gray, Kelly Green, Maroon, Navy Blue, Black, Purple, Orange, Carolina Blue, Yellow, White	Humphreys	AM-WTP-30X50	EACH	\$ 2,010.000	5.0%	\$ 100.500	\$ 1,909.500	+ shipping - see freight notes	71
72	Track & Field	9	9	ARMOR MESH WEIGHTED TRACK PROTECTORS - Heavy duty 14 oz. vinyl coated woven polyester 15' x 100' - Colors: Dark Green, Royal Blue, Red, Light Gray, Kelly Green, Maroon, Navy Blue, Black, Purple, Orange, Carolina Blue, Yellow, White	Humphreys	AM-WTP-C<300	SF	\$ 2.390	5.0%	\$ 0.120	\$ 2.271	+ shipping - see freight notes	72
73	Track & Field	9	9	ARMOR MESH WEIGHTED TRACK PROTECTORS - Heavy duty 14 oz. vinyl coated woven polyester 15' x 100' - Colors: Dark Green, Royal Blue, Red, Light Gray, Kelly Green, Maroon, Navy Blue, Black, Purple, Orange, Carolina Blue, Yellow, White	Humphreys	AM-WTP-C>300	SF	\$ 2.180	5.0%	\$ 0.109	\$ 2.071	+ shipping - see freight notes	73
74	Track & Field	9	9	LETTERING & NUMBERS - 42" HIGH ONE OR MULTI-COLORED LETTER	Humphreys	LTRS/#42C	EACH	\$ 70.000	5.0%	\$ 3.500	\$ 66.500	+ shipping - see freight notes	74

Bidding Company Name:				Partac Peat Corporation	Catalog Name:		9 - Running Tracks / Shot Put Sector Surfacing / Long Jump Pits						
No.	Product Category	Beam Clay Catalog Section #	Page#	Product Description	Manufacturer	Vendor SKU	Unit of Measure	Catalog List Price	Bid Discount Percentage	Discount Amt.	Net Effective Bid Price	Comments	No.
75	Track & Field	9	9	LETTERING & NUMBERS - 48" HIGH ONE OR MULTI-COLORED LETTER	Humphreys	LTRS/#48C	EACH	\$ 81.000	5.0%	\$ 4.050	\$ 76.950	+ shipping - see freight notes	75
76	Track & Field	9	9	LETTERING & NUMBERS - 54" HIGH ONE OR MULTI-COLORED LETTER	Humphreys	LTRS/#54C	EACH	\$ 94.000	5.0%	\$ 4.700	\$ 89.300	+ shipping - see freight notes	76
77	Track & Field	9	9	LETTERING & NUMBERS - 60" HIGH ONE OR MULTI-COLORED LETTER	Humphreys	LTRS/#60C	EACH	\$ 108.000	5.0%	\$ 5.400	\$ 102.600	+ shipping - see freight notes	77
78	Track & Field	9	9	LETTERING & NUMBERS - MINIMUM ONE OR MULTI-COLORED LETTER	Humphreys	LTRS/#MINC	EACH	\$ 275.000	5.0%	\$ 13.750	\$ 261.250	+ shipping - see freight notes	78
79	Track & Field	9	9	CUSTOM LOGOS - ONE OR MULTI-COLORED IMAGE UP TO 15 SF (EX. 3' X 5')	Humphreys	LOGOS-C-15SF	EACH	\$ 295.000	5.0%	\$ 14.750	\$ 280.250	+ shipping - see freight notes	79
80	Track & Field	9	9	CUSTOM LOGOS - ONE OR MULTI-COLORED IMAGE UP TO 30 SF (EX. 5' X 6')	Humphreys	LOGOS-C-30SF	EACH	\$ 375.000	5.0%	\$ 18.750	\$ 356.250	+ shipping - see freight notes	80
81	Track & Field	9	9	CUSTOM LOGOS - ONE OR MULTI-COLORED IMAGE UP TO 50 SF (EX. 5' X 10')	Humphreys	LOGOS-C-50SF	EACH	\$ 565.000	5.0%	\$ 28.250	\$ 536.750	+ shipping - see freight notes	81
82	Track & Field	9	9	CUSTOM LOGOS - ONE OR MULTI-COLORED IMAGE UP TO 100 SF (EX. 10' X 10') - #LOGOS-C-100SF	Humphreys	LOGOS-C-100SF	EACH	\$ 995.000	5.0%	\$ 49.750	\$ 945.250	+ shipping - see freight notes	82
83	Track & Field	9	10	BENCH ZONE SIDELINE TRACK PROTECTOR - 15' x 75' - #BZST1575	Aer-Flo	BZST1575	EACH	\$ 1,250.000	5.0%	\$ 62.500	\$ 1,187.500	+ shipping - see freight notes	83
84	Track & Field	9	10	BENCH ZONE SIDELINE TRACK PROTECTOR - 15' x 100' - #BZST15100	Aer-Flo	BZST15100	EACH	\$ 1,535.000	5.0%	\$ 76.750	\$ 1,458.250	+ shipping - see freight notes	84
85	Track & Field	9	10	BENCH ZONE SIDELINE TRACK PROTECTOR - 15' x 125' - #BZST15125	Aer-Flo	BZST15125	EACH	\$ 1,895.000	5.0%	\$ 94.750	\$ 1,800.250	+ shipping - see freight notes	85
86	Track & Field	9	10	BENCH ZONE SIDELINE TRACK PROTECTOR - 15' x 150' - #BZST15150	Aer-Flo	BZST15150	EACH	\$ 2,250.000	5.0%	\$ 112.500	\$ 2,137.500	+ shipping - see freight notes	86
87	Track & Field	9	10	BENCH ZONE SIDELINE TRACK PROTECTOR - CUSTOM SIZES, OVER 801 SF - #BZSTX	Aer-Flo	BZSTX	SF	\$ 1.250	5.0%	\$ 0.063	\$ 1.188	+ shipping - see freight notes	87
88	Track & Field	9	11	BENCH ZONE 2G/3G TRACK PROTECTORS - CUSTOM SIZES, UP TO 800 SF #2GCOX	Aer-Flo	2GCOX	SF	\$ 4.250	5.0%	\$ 0.213	\$ 4.038	+ shipping - see freight notes	88
89	Track & Field	9	11	BENCH ZONE 2G/3G TRACK PROTECTORS - CUSTOM SIZES, OVER 800 SF #2GBZSTX	Aer-Flo	2GBZSTX	SF	\$ 2.950	5.0%	\$ 0.148	\$ 2.803	+ shipping - see freight notes	89
90	Track & Field	9	11	6 X 30 3RD GENERATION TRACK PROTECTOR, ENKA AND VIPOL® MATRIX MESH OVERLAY #3GCO630	Aer-Flo	3GCO630	EACH	\$ 550.000	5.0%	\$ 27.500	\$ 522.500	+ shipping - see freight notes	90
91	Track & Field	9	11	6 X 40 3RD GENERATION TRACK PROTECTOR, ENKA AND VIPOL® MATRIX MESH OVERLAY #3GCO640	Aer-Flo	3GCO640	EACH	\$ 725.000	5.0%	\$ 36.250	\$ 688.750	+ shipping - see freight notes	91
92	Track & Field	9	11	6 X 50 3RD GENERATION TRACK PROTECTOR, ENKA AND VIPOL® MATRIX MESH OVERLAY #3GCO650	Aer-Flo	3GCO650	EACH	\$ 865.000	5.0%	\$ 43.250	\$ 821.750	+ shipping - see freight notes	92
93	Track & Field	9	11	12 X 30 3RD GENERATION TRACK PROTECTOR, ENKA AND VIPOL® MATRIX MESH OVERLAY #3GCO1230	Aer-Flo	3GCO1230	EACH	\$ 975.000	5.0%	\$ 48.750	\$ 926.250	+ shipping - see freight notes	93
94	Track & Field	9	11	12 X 40 3RD GENERATION TRACK PROTECTOR, ENKA AND VIPOL® MATRIX MESH OVERLAY #3GCO1240	Aer-Flo	3GCO1240	EACH	\$ 1,250.000	5.0%	\$ 62.500	\$ 1,187.500	+ shipping - see freight notes	94
95	Track & Field	9	11	12 X 50 3RD GENERATION TRACK PROTECTOR, ENKA AND VIPOL® MATRIX MESH OVERLAY #3GCO1250	Aer-Flo	3GCO1250	EACH	\$ 1,525.000	5.0%	\$ 76.250	\$ 1,448.750	+ shipping - see freight notes	95
96	Track & Field	9	12	CROSS-OVER ZONE TRACK PROTECTORS - 15' X 30' - #CO1530	Aer-Flo	CO1530	EACH	\$ 665.000	5.0%	\$ 33.250	\$ 631.750	+ shipping - see freight notes	96
97	Track & Field	9	12	CROSS-OVER ZONE TRACK PROTECTORS - 15' X 40' - #CO1540	Aer-Flo	CO1540	EACH	\$ 810.000	5.0%	\$ 40.500	\$ 769.500	+ shipping - see freight notes	97
98	Track & Field	9	12	CROSS-OVER ZONE TRACK PROTECTORS - 15' X 50' - #CO1550	Aer-Flo	CO1550	EACH	\$ 985.000	5.0%	\$ 49.250	\$ 935.750	+ shipping - see freight notes	98
99	Track & Field	9	12	CROSS-OVER ZONE TRACK PROTECTORS - 7.5' X 30' - #CO7530	Aer-Flo	CO7530	EACH	\$ 465.000	5.0%	\$ 23.250	\$ 441.750	+ shipping - see freight notes	99

Bidding Company Name:				Partac Peat Corporation	Catalog Name:		9 - Running Tracks / Shot Put Sector Surfacing / Long Jump Pits					No.	
No.	Product Category	Beam Clay Catalog Section #	Page#	Product Description	Manufacturer	Vendor SKU	Unit of Measure	Catalog List Price	Bid Discount Percentage	Discount Amt.	Net Effective Bid Price	Comments	No.
100	Track & Field	9	12	CROSS-OVER ZONE TRACK PROTECTORS - 7.5' X 40' - #CO7540	Aer-Flo	CO7540	EACH	\$ 565.000	5.0%	\$ 28.250	\$ 536.750	+ shipping - see freight notes	100
101	Track & Field	9	12	CROSS-OVER ZONE TRACK PROTECTORS - 7.5' X 50' - #CO7550	Aer-Flo	CO7550	EACH	\$ 685.000	5.0%	\$ 34.250	\$ 650.750	+ shipping - see freight notes	101
102	Track & Field	9	12	CROSS-OVER ZONE TRACK PROTECTORS -CUSTOM SIZES, UP TO 800 SF #COX	Aer-Flo	COX	SF	\$ 2.250	5.0%	\$ 0.113	\$ 2.138	+ shipping - see freight notes	102
103	Track & Field	9	12	CROSS-OVER ZONE TRACK PROTECTORS - 18 OZ. VINYL BORDER, COLORS OTHER THAN WHITE OR GOLD - NO CHARGE	Aer-Flo	TPVB-C	EACH	N/C					103
104	Track & Field	9	12	CROSS-OVER ZONE 2G/3G TRACK PROTECTORS CUSTOM SIZES UP TO 800 SF - #3GCOX	Aer-Flo	3GCOX	SF	\$ 4.250	5.0%	\$ 0.213	\$ 4.038	+ shipping - see freight notes	104
105	Track & Field	9	12	CROSS-OVER ZONE 2G/3G TRACK PROTECTORS CUSTOM SIZES OVER 800 SF - #3GBZSTX	Aer-Flo	3GBZSTX	SF	\$ 2.950	5.0%	\$ 0.148	\$ 2.803	+ shipping - see freight notes	105
106	Track & Field	9	12	CROSS-OVER ZONE 2G TRACK PROTECTORS - 18 oz. Vinyl border, colors other than White or Gold	Aer-Flo	TPVB-C	EACH	N/C	5.0%				106
107	Track & Field	9	12	CROSS-OVER ZONE 3G TRACK PROTECTORS - 3rd Gen Track Protector, Enka Mat & VIPOL Matrix Overlay 12 x 75 #3GBZST1275	Aer-Flo	3GBZST1275	EACH	\$ 1,965.000	5.0%				
108	Track & Field	9	12	CROSS-OVER ZONE 3G TRACK PROTECTORS - 3rd Gen Track Protector, Enka Mat & VIPOL Matrix Overlay 12 x 100 #3GBZST12100	Aer-Flo	3GBZST12100	EACH	\$ 2,495.000	5.0%				
109	Track & Field	9	12	CROSS-OVER ZONE 3G TRACK PROTECTORS - 3rd Gen Track Protector, Enka Mat & VIPOL Matrix Overlay 12 x 125 #3GBZST12125	Aer-Flo	3GBZST12125	EACH	\$ 2,985.000	5.0%				
110	Track & Field	9	12	CROSS-OVER ZONE 3G TRACK PROTECTORS - 3rd Gen Track Protector, Enka Mat & VIPOL Matrix Overlay 12 x 150 #3GBZST12150	Aer-Flo	3GBZST12150	EACH	\$ 3,495.000	5.0%				
#REF!	Track & Field	9	12	CROSS-OVER ZONE 3G TRACK PROTECTORS - 3rd Gen Track Protector, Enka Mat & VIPOL Matrix Overlay 6' x 40' #3GCO630	Aer-Flo	3GCO630	EACH	\$ 550.000	5.0%	\$ 27.500	\$ 522.500	+ shipping - see freight notes	#REF!
#REF!	Track & Field	9	12	CROSS-OVER ZONE 3G TRACK PROTECTORS - 3rd Gen Track Protector, Enka Mat & VIPOL Matrix Overlay 6' x 40' #3GCO640	Aer-Flo	3GCO640	EACH	\$ 710.000	5.0%	\$ 35.500	\$ 674.500	+ shipping - see freight notes	#REF!
#REF!	Track & Field	9	12	CROSS-OVER ZONE 3G TRACK PROTECTORS - 3rd Gen Track Protector, Enka Mat & VIPOL Matrix Overlay 6' x 50' #3GCO650	Aer-Flo	3GCO650	EACH	\$ 865.000	5.0%	\$ 43.250	\$ 821.750	+ shipping - see freight notes	#REF!
#REF!	Track & Field	9	12	CROSS-OVER ZONE 3G TRACK PROTECTORS - 3rd Gen Track Protector, Enka Mat & VIPOL Matrix Overlay 12' X 30' #3GCO1230	Aer-Flo	3GCO1230	EACH	\$ 975.000	5.0%	\$ 48.750	\$ 926.250	+ shipping - see freight notes	#REF!
#REF!	Track & Field	9	12	CROSS-OVER ZONE 3G TRACK PROTECTORS - 3rd Gen Track Protector, Enka Mat & VIPOL Matrix Overlay 12' X 40' #3GCO1240	Aer-Flo	3GCO1240	EACH	\$ 1,255.000	5.0%	\$ 62.750	\$ 1,192.250	+ shipping - see freight notes	#REF!
#REF!	Track & Field	9	12	CROSS-OVER ZONE 3G TRACK PROTECTORS - 3rd Gen Track Protector, Enka Mat & VIPOL Matrix Overlay 12' X 50' #3GCO1250	Aer-Flo	3GCO1250	EACH	\$ 1,525.000	5.0%	\$ 76.250	\$ 1,448.750	+ shipping - see freight notes	#REF!
#REF!	Track & Field	9	22	LONG JUMP SAND - WHITE SAND - EXTRA FINE - BULK - SJ PLANT	Partac Peat Corporation	WEF-SJBU	TON	\$ 27.000	5.0%	\$ 1.350	\$ 25.650	+ shipping - see freight notes	#REF!
#REF!	Track & Field	9	22	LONG JUMP SAND - WHITE SAND - EXTRA WHITE FINE - BAG - NJ PLANT	Partac Peat Corporation	XWF-NJBAG	50 LB BAG	\$ 5.500	5.0%	\$ 0.275	\$ 5.225	+ shipping - see freight notes	#REF!
#REF!	Track & Field	9	22	LONG JUMP SAND - WHITE SAND - MEDIUM - BULK - SJ PLANT	Partac Peat Corporation	WM-SJBU	TON	\$ 25.000	5.0%	\$ 1.250	\$ 23.750	+ shipping - see freight notes	#REF!
#REF!	Track & Field	9	22	LONG JUMP SAND - WHITE SAND - MEDIUM DOUBLE SCREENED - BULK - NJ PLANT	Partac Peat Corporation	WM-DS-NJBU	TON	\$ 48.000	5.0%	\$ 2.400	\$ 45.600	+ shipping - see freight notes	#REF!
#REF!	Track & Field	9	22	LONG JUMP SAND - WHITE SAND - MEDIUM DOUBLE SCREENED - BAG - NJ PLANT	Partac Peat Corporation	WM-DS-NJBAG	50 LB BAG	\$ 5.250	5.0%	\$ 0.263	\$ 4.988	+ shipping - see freight notes	#REF!
#REF!	Track & Field	9	22	LONG JUMP SAND - WHITE SAND - MEDIUM/ HEAT TREATED - BULK- NJ PLANT	Partac Peat Corporation	WM-WH-HT-NJBU	TON	\$ 69.000	5.0%	\$ 3.450	\$ 65.550	+ shipping - see freight notes	#REF!
#REF!	Track & Field	9	22	LONG JUMP SAND - WHITE SAND - MEDIUM /HEAT TREATED - BAG - NJ PLANT	Partac Peat Corporation	WM-WH-HT-NJBAG	50 LB BAG	\$ 5.500	5.0%	\$ 0.275	\$ 5.225	+ shipping - see freight notes	#REF!
#REF!	Track & Field	9	23	LONG JUMP SAND - WHITE SAND - WHITE MEDIUM - BULK - NJ PLANT	Partac Peat Corporation	WM-NJBU	TON	\$ 45.000	5.0%	\$ 2.250	\$ 42.750	+ shipping - see freight notes	#REF!

Bidding Company Name:				Partac Peat Corporation	Catalog Name:		9 - Running Tracks / Shot Put Sector Surfacing / Long Jump Pits						
No.	Product Category	Beam Clay Catalog Section #	Page#	Product Description	Manufacturer	Vendor SKU	Unit of Measure	Catalog List Price	Bid Discount Percentage	Discount Amt.	Net Effective Bid Price	Comments	No.
#REF!	Track & Field	9	22	LONG JUMP SAND - WHITE SAND - WHITE MEDIUM-FIRM - BULK - NJ PLANT	Partac Peat Corporation	WMF-SJBU	TON	\$ 27.000	5.0%	\$ 1.350	\$ 25.650	+ shipping - see freight notes	#REF!
#REF!	Track & Field	9	22	LONG JUMP SAND - WHITE SAND - WHITE MEDIUM-COARSE - BULK - SJ PLANT	Partac Peat Corporation	WMC-SJBU	TON	\$ 29.000	5.0%	\$ 1.450	\$ 27.550	+ shipping - see freight notes	#REF!
#REF!	Track & Field	9	22	LONG JUMP SAND - WHITE SAND - FINE - BULK - SJ PLANT	Partac Peat Corporation	WF-SJBU	TON	\$ 55.000	5.0%	\$ 2.750	\$ 52.250	+ shipping - see freight notes	#REF!
#REF!	Track & Field	9	22	LONG JUMP SAND - WHITE SAND - VERY FINE - BULK - SJ PLANT	Partac Peat Corporation	WVF-SJBU	TON	\$ 25.000	5.0%	\$ 1.250	\$ 23.750	+ shipping - see freight notes	#REF!
#REF!	Track & Field	9	22	LONG JUMP SAND - BRIGHT WHITE SAND - CRUSHED MARBLE/Medium Coase- BULK - MA PLANT	Partac Peat Corporation	SW-MC-MABU	TON	\$ 50.000	5.0%	\$ 2.500	\$ 47.500	+ shipping - see freight notes	#REF!
#REF!	Track & Field	9	22	LONG JUMP SAND - WHITE #30/50 SAND - HEAT-TREATED - BULK - SJ PLANT	Partac Peat Corporation	WHT3050-SJBU	TON	\$ 88.000	5.0%	\$ 4.400	\$ 83.600	+ shipping - see freight notes	#REF!
#REF!	Track & Field	9	22	LONG JUMP SAND - WHITE #30/50 SAND - HEAT-TREATED - 3,000 LB. BULK BAG - SJ PLANT	Partac Peat Corporation	WHT3050-SJBB	3,000 LB. BAG	\$ 300.000	5.0%	\$ 15.000	\$ 285.000	+ shipping - see freight notes	#REF!
#REF!	Track & Field	9	22	LONG JUMP SAND - WHITE /HEAT-TREATED - #20/40 - BULK - SJ PLANT	Partac Peat Corporation	WHT2040-SJBU	TON	\$ 90.000	5.0%	\$ 4.500	\$ 85.500	+ shipping - see freight notes	#REF!
#REF!	Track & Field	9	22	LONG JUMP SAND - WHITE /HEAT-TREATED - #20/40 -3,000 LBS. BULK BAG - SJ PLANT	Partac Peat Corporation	WHT2040-SJBB	3,000 LB. BAG	\$ 310.000	5.0%	\$ 15.500	\$ 294.500	+ shipping - see freight notes	#REF!
#REF!	Track & Field	9	22	LONG JUMP SAND - WHITE /HEAT-TREATED - #16/30 - BULK - SJ PLANT	Partac Peat Corporation	WHT1630-SJBU	TON	\$ 100.000	5.0%	\$ 5.000	\$ 95.000	+ shipping - see freight notes	#REF!
#REF!	Track & Field	9	22	LONG JUMP SAND - WHITE /HEAT-TREATED - #16/30 -3,000 LBS. BULK BAG - SJ PLANT	Partac Peat Corporation	WHT1630-SJBB	3,000 LB BAG	\$ 415.000	5.0%	\$ 20.750	\$ 394.250	+ shipping - see freight notes	#REF!
#REF!	Track & Field	9	22	LONG JUMP SAND - WHITE /HEAT-TREATED - #18/60 - BULK - SJ PLANT	Partac Peat Corporation	WHT1860-SJBU	TON	\$ 70.000	5.0%	\$ 3.500	\$ 66.500	+ shipping - see freight notes	#REF!
#REF!	Track & Field	9	22	LONG JUMP SAND - WHITE /HEAT-TREATED - #18/60 -3,000 LBS. BULK BAG - SJ PLANT	Partac Peat Corporation	WHT1860-SJBB	3,000 LB BAG	\$ 198.000	5.0%	\$ 9.900	\$ 188.100	+ shipping - see freight notes	#REF!
#REF!	Track & Field	9	22	LONG JUMP SAND - WHITE /HEAT-TREATED - #18/100 - BULK - SJ PLANT	Partac Peat Corporation	WHT18100-SJBU	TON	\$ 65.000	5.0%	\$ 3.250	\$ 61.750	+ shipping - see freight notes	#REF!
#REF!	Track & Field	9	22	LONG JUMP SAND - WHITE /HEAT-TREATED - #18/100 -3,000 LBS. BULK BAG - SJ PLANT	Partac Peat Corporation	WHT18100-SJBB	3,000 LB BAG	\$ 175.000	5.0%	\$ 8.750	\$ 166.250	+ shipping - see freight notes	#REF!
#REF!	Track & Field	9	22	LONG JUMP SAND - WHITE /HEAT-TREATED - #35/70 - BULK - SJ PLANT	Partac Peat Corporation	WHT3570-SJBU	TON	\$ 70.000	5.0%	\$ 3.500	\$ 66.500	+ shipping - see freight notes	#REF!
#REF!	Track & Field	9	22	LONG JUMP SAND - WHITE /HEAT-TREATED - #35/70 -3,000 LBS. BULK BAG - SJ PLANT	Partac Peat Corporation	WHT3570-SJBB	3,000 LB BAG	\$ 190.000	5.0%	\$ 9.500	\$ 180.500	+ shipping - see freight notes	#REF!
#REF!	Track & Field	9	22	LONG JUMP SAND - WHITE /HEAT-TREATED - #35/100 - BULK - SJ PLANT	Partac Peat Corporation	WHT35100-SJBU	TON	\$ 50.000	5.0%	\$ 2.500	\$ 47.500	+ shipping - see freight notes	#REF!
#REF!	Track & Field	9	22	LONG JUMP SAND - WHITE /HEAT-TREATED - #35/100 -3,000 LBS. BULK BAG - SJ PLANT	Partac Peat Corporation	WHT35100-SJBB	3,000 LB BAG	\$ 170.000	5.0%	\$ 8.500	\$ 161.500	+ shipping - see freight notes	#REF!
#REF!	Track & Field	9	22	LONG JUMP SAND - WHITE /HEAT-TREATED - 40/100 - BULK - SJ PLANT	Partac Peat Corporation	WHT40100-SJBU	TON	\$ 88.000	5.0%	\$ 4.400	\$ 83.600	+ shipping - see freight notes	#REF!
#REF!	Track & Field	9	22	LONG JUMP SAND - WHITE /HEAT-TREATED - #40/100 -3,000 LBS. BULK BAG - SJ PLANT	Partac Peat Corporation	WHT40100-SJBB	3,000 LB BAG	\$ 335.000	5.0%	\$ 16.750	\$ 318.250	+ shipping - see freight notes	#REF!
#REF!	Track & Field	9	23	LANDING ZONE BALLASTED PIT COVERS - LZ Ballasted Pit Cover made with 10 oz. Vipol Matrix Mesh—Available in 23 colors! #LZXVIPOL	Aer-Flo	LZXVIPOL	SF	\$ 2.950	5.0%	\$ 0.148	\$ 2.803	+ shipping - see freight notes	#REF!
#REF!	Track & Field	9	23	LANDING ZONE BALLASTED PIT COVERS - LZ Ballasted Pit Cover made with 18 oz. Solid Vinyl—Available in 17 colors! - LZXVINYL	Aer-Flo	LZXVINYL	SF	\$ 2.900	5.0%	\$ 0.145	\$ 2.755	+ shipping - see freight notes	#REF!
#REF!	Track & Field	9	13	CHROMA-BOND IMPRINTING 1 COLOR LOGO ONLY - UP TO 255F - 1COL255F	Aer-Flo	1COL255F	EACH	\$ 550.000	5.0%	\$ 27.500	\$ 522.500	+ shipping - see freight notes	#REF!
#REF!	Track & Field	9	13	CHROMA-BOND IMPRINTING 1 COLOR LOGO ONLY - 265F-505F - 1COL26505F	Aer-Flo	1COL26505F	EACH	\$ 725.000	5.0%	\$ 36.250	\$ 688.750	+ shipping - see freight notes	#REF!

Bidding Company Name:				Partac Peat Corporation	Catalog Name:		9 - Running Tracks / Shot Put Sector Surfacing / Long Jump Pits						
No.	Product Category	Beam Clay Catalog Section #	Page#	Product Description	Manufacturer	Vendor SKU	Unit of Measure	Catalog List Price	Bid Discount Percentage	Discount Amt.	Net Effective Bid Price	Comments	No.
#REF!	Track & Field	9	13	CHROMA-BOND IMPRINTING 1 COLOR LOGO ONLY - 51SF-100SF - 1COL51100SF	Aer-Flo	1COL51100SF	EACH	\$ 995.000	5.0%	\$ 49.750	\$ 945.250	+ shipping - see freight notes	#REF!
#REF!	Track & Field	9	13	CHROMA-BOND IMPRINTING 2 COLOR LOGO ONLY - UP TO 25SF - 2COL25SF	Aer-Flo	2COL25SF	EACH	\$ 675.000	5.0%	\$ 33.750	\$ 641.250	+ shipping - see freight notes	#REF!
#REF!	Track & Field	9	13	CHROMA-BOND IMPRINTING 2 COLOR LOGO ONLY - 26SF-50SF - 2COL2650SF	Aer-Flo	2COL2650SF	EACH	\$ 850.000	5.0%	\$ 42.500	\$ 807.500	+ shipping - see freight notes	#REF!
#REF!	Track & Field	9	13	CHROMA-BOND IMPRINTING 2 COLOR LOGO ONLY - 51SF-100SF - 2COL51100SF	Aer-Flo	2COL51100SF	EACH	\$ 1,150.000	5.0%	\$ 57.500	\$ 1,092.500	+ shipping - see freight notes	#REF!
#REF!	Track & Field	9	13	CHROMA-BOND IMPRINTING 3 COLOR LOGO ONLY - UP TO 25SF - 3COL25SF	Aer-Flo	3COL25SF	EACH	\$ 760.000	5.0%	\$ 38.000	\$ 722.000	+ shipping - see freight notes	#REF!
#REF!	Track & Field	9	13	CHROMA-BOND IMPRINTING 3 COLOR LOGO ONLY - 26SF-50SF - 3COL2650SF	Aer-Flo	3COL2650SF	EACH	\$ 925.000	5.0%	\$ 46.250	\$ 878.750	+ shipping - see freight notes	#REF!
#REF!	Track & Field	9	13	CHROMA-BOND IMPRINTING 3 COLOR LOGO ONLY - 51SF-100SF - 3COL51100SF	Aer-Flo	3COL51100SF	EACH	\$ 1,215.000	5.0%	\$ 60.750	\$ 1,154.250	+ shipping - see freight notes	#REF!
#REF!	Track & Field	9	13	CHROMA-BOND IMPRINTING 1 COLOR LTRS. OR NUMBERS - UP TO 24" TALL - 1COL24	Aer-Flo	1COL24	EACH	\$ 56.000	5.0%	\$ 2.800	\$ 53.200	+ shipping - see freight notes	#REF!
#REF!	Track & Field	9	13	CHROMA-BOND IMPRINTING 1 COLOR LTRS. OR NUMBERS - UP TO 36" TALL - 1COL36	Aer-Flo	1COL36	EACH	\$ 68.000	5.0%	\$ 3.400	\$ 64.600	+ shipping - see freight notes	#REF!
#REF!	Track & Field	9	13	CHROMA-BOND IMPRINTING 1 COLOR LTRS. OR NUMBERS - UP TO 48" TALL - 1COL48	Aer-Flo	1COL48	EACH	\$ 84.000	5.0%	\$ 4.200	\$ 79.800	+ shipping - see freight notes	#REF!
#REF!	Track & Field	9	13	CHROMA-BOND IMPRINTING 1 COLOR LTRS. OR NUMBERS - UP TO 60" TALL - 1COL60	Aer-Flo	1COL60	EACH	\$ 98.000	5.0%	\$ 4.900	\$ 93.100	+ shipping - see freight notes	#REF!
#REF!	Track & Field	9	13	CHROMA-BOND IMPRINTING 1 COLOR LTRS. OR NUMBERS - UP TO 72" TALL - 1COL72	Aer-Flo	1COL72	EACH	\$ 120.000	5.0%	\$ 6.000	\$ 114.000	+ shipping - see freight notes	#REF!
#REF!	Track & Field	9	13	CHROMA-BOND IMPRINTING 1 COLOR LTRS. OR NUMBERS - UP TO 84" TALL - 1COL84	Aer-Flo	1COL84	EACH	\$ 131.000	5.0%	\$ 6.550	\$ 124.450	+ shipping - see freight notes	#REF!
#REF!	Track & Field	9	13	CHROMA-BOND IMPRINTING 1 COLOR LTRS. OR NUMBERS - UP TO 96" TALL - 1COL96	Aer-Flo	1COL96	EACH	\$ 150.000	5.0%	\$ 7.500	\$ 142.500	+ shipping - see freight notes	#REF!
#REF!	Track & Field	9	13	CHROMA-BOND IMPRINTING 1 COLOR LTRS. OR NUMBERS - UP TO 108" TALL - 1COL108	Aer-Flo	1COL108	EACH	\$ 178.000	5.0%	\$ 8.900	\$ 169.100	+ shipping - see freight notes	#REF!
#REF!	Track & Field	9	13	CHROMA-BOND IMPRINTING 1 COLOR LTRS. OR NUMBERS - UP TO 120" TALL - 1COL120	Aer-Flo	1COL120	EACH	\$ 206.000	5.0%	\$ 10.300	\$ 195.700	+ shipping - see freight notes	#REF!
#REF!	Track & Field	9	13	CHROMA-BOND IMPRINTING 2 COLOR LTRS. OR NUMBERS - UP TO 24" TALL - 2COL24	Aer-Flo	2COL24	EACH	\$ 76.000	5.0%	\$ 3.800	\$ 72.200	+ shipping - see freight notes	#REF!
#REF!	Track & Field	9	13	CHROMA-BOND IMPRINTING 2 COLOR LTRS. OR NUMBERS - UP TO 36" TALL - 2COL36	Aer-Flo	2COL36	EACH	\$ 88.000	5.0%	\$ 4.400	\$ 83.600	+ shipping - see freight notes	#REF!
#REF!	Track & Field	9	13	CHROMA-BOND IMPRINTING 2 COLOR LTRS. OR NUMBERS - UP TO 48" TALL - 2COL48	Aer-Flo	2COL48	EACH	\$ 104.000	5.0%	\$ 5.200	\$ 98.800	+ shipping - see freight notes	#REF!
#REF!	Track & Field	9	13	CHROMA-BOND IMPRINTING 2 COLOR LTRS. OR NUMBERS - UP TO 60" TALL - 2COL60	Aer-Flo	2COL60	EACH	\$ 118.000	5.0%	\$ 5.900	\$ 112.100	+ shipping - see freight notes	#REF!
#REF!	Track & Field	9	13	CHROMA-BOND IMPRINTING 2 COLOR LTRS. OR NUMBERS - UP TO 72" TALL - 2COL72	Aer-Flo	2COL72	EACH	\$ 139.000	5.0%	\$ 6.950	\$ 132.050	+ shipping - see freight notes	#REF!
#REF!	Track & Field	9	13	CHROMA-BOND IMPRINTING 2 COLOR LTRS. OR NUMBERS - UP TO 84" TALL - 2COL84	Aer-Flo	2COL84	EACH	\$ 151.000	5.0%	\$ 7.550	\$ 143.450	+ shipping - see freight notes	#REF!
#REF!	Track & Field	9	13	CHROMA-BOND IMPRINTING 2 COLOR LTRS. OR NUMBERS - UP TO 96" TALL - 2COL96	Aer-Flo	2COL96	EACH	\$ 171.000	5.0%	\$ 8.550	\$ 162.450	+ shipping - see freight notes	#REF!
#REF!	Track & Field	9	13	CHROMA-BOND IMPRINTING 2 COLOR LTRS. OR NUMBERS - UP TO 108" TALL - 2COL108	Aer-Flo	2COL108	EACH	\$ 198.000	5.0%	\$ 9.900	\$ 188.100	+ shipping - see freight notes	#REF!
#REF!	Track & Field	9	13	CHROMA-BOND IMPRINTING 2 COLOR LTRS. OR NUMBERS - UP TO 120" TALL - 2COL120	Aer-Flo	2COL120	EACH	\$ 226.000	5.0%	\$ 11.300	\$ 214.700	+ shipping - see freight notes	#REF!

Bidding Company Name:				Partac Peat Corporation	Catalog Name:		9 - Running Tracks / Shot Put Sector Surfacing / Long Jump Pits						
No.	Product Category	Beam Clay Catalog Section #	Page#	Product Description	Manufacturer	Vendor SKU	Unit of Measure	Catalog List Price	Bid Discount Percentage	Discount Amt.	Net Effective Bid Price	Comments	No.
#REF!	Track & Field	9	14	STACKHOUSE HURDLES - Cantabrian Aluminum INTERNATIONAL Hurdle - TICH-ADJC	Stackhouse	TICH-ADJC	EACH	\$ 245.000	5.0%	\$ 12.250	\$ 232.750	+ shipping - see freight notes	#REF!
#REF!	Track & Field	9	14	STACKHOUSE HURDLES - Elite Aluminum H.S. Hurdle - TEHS	Stackhouse	TEHS	EACH	\$ 195.000	5.0%	\$ 9.750	\$ 185.250	+ shipping - see freight notes	#REF!
#REF!	Track & Field	9	14	STACKHOUSE HURDLES - Elite Aluminum College Hurdle - TECH	Stackhouse	TECH	EACH	\$ 215.000	5.0%	\$ 10.750	\$ 204.250	+ shipping - see freight notes	#REF!
#REF!	Track & Field	9	14	STACKHOUSE HURDLES - D. Regal "L" Hurdle - TRLH	Stackhouse	TRLH	EACH	\$ 130.000	5.0%	\$ 6.500	\$ 123.500	+ shipping - see freight notes	#REF!
#REF!	Track & Field	9	15	STACKHOUSE HURDLES - Aluminum H.S. Rocker Hurdle - TARH	Stackhouse	TARH	EACH	\$ 135.000	5.0%	\$ 6.750	\$ 128.250	+ shipping - see freight notes	#REF!
#REF!	Track & Field	9	15	STACKHOUSE HURDLES - Cantabrian Aluminum High School Open Face Hurdle - TCOFH	Stackhouse	TCOFH	EACH	\$ 169.000	5.0%	\$ 8.450	\$ 160.550	+ shipping - see freight notes	#REF!
#REF!	Track & Field	9	15	STACKHOUSE HURDLES - Aluminum One-Piece High School Rocker Hurdle -THAER	Stackhouse	THAER	EACH	\$ 115.000	5.0%	\$ 5.750	\$ 109.250	+ shipping - see freight notes	#REF!
#REF!	Track & Field	9	15	STACKHOUSE HURDLES - Junior Elementary Hurdle -TJEH	Stackhouse	TJEH	EACH	\$ 105.000	5.0%	\$ 5.250	\$ 99.750	+ shipping - see freight notes	#REF!
#REF!	Track & Field	9	16	TSI/OLYMPIA HURDLES - Olympia Aluminum Super Hurdle - HOAS	TSI	HOAS	EACH	\$ 265.000	5.0%	\$ 13.250	\$ 251.750	+ shipping - see freight notes	#REF!
#REF!	Track & Field	9	16	TSI/OLYMPIA HURDLES - Olympia Aluminum Competition Hurdle - HOAC	TSI	HOAC	EACH	\$ 250.000	5.0%	\$ 12.500	\$ 237.500	+ shipping - see freight notes	#REF!
#REF!	Track & Field	9	16	TSI/OLYMPIA HURDLES - Club Rocker Hurdle - HROCK	TSI	HROCK	EACH	\$ 115.000	5.0%	\$ 5.750	\$ 109.250	+ shipping - see freight notes	#REF!
#REF!	Track & Field	9	16	TSI/OLYMPIA HURDLES - Adjustable Training Hurdle - HATH	TSI	HATH	EACH	\$ 50.000	5.0%	\$ 2.500	\$ 47.500	+ shipping - see freight notes	#REF!
#REF!	Track & Field	9	17	HURDLE CARTS/FIELD WAGONS - Hanging Hurdle Cart - THHC	Stackhouse	THHC	EACH	\$ 649.000	5.0%	\$ 32.450	\$ 616.550	+ shipping - see freight notes	#REF!
#REF!	Track & Field	9	17	HURDLE CARTS/FIELD WAGONS - Super Field Wagon, 1000 lb. Capacity, 5' x 10' - TFFAC510	Stackhouse	TFFAC510	EACH	\$ 2,295.000	5.0%	\$ 114.750	\$ 2,180.250	+ shipping - see freight notes	#REF!
#REF!	Track & Field	9	17	HURDLE CARTS/FIELD WAGONS - Super Field Wagon, 1000 lb. Capacity, 4' X 8' - TFFAC48	Stackhouse	TFFAC48	EACH	\$ 1,795.000	5.0%	\$ 89.750	\$ 1,705.250	+ shipping - see freight notes	#REF!
#REF!	Track & Field	9	17	HURDLE CARTS/FIELD WAGONS - Cantabrian Flight Hurdle Cart - THFC	Stackhouse	THFC	EACH	\$ 295.000	5.0%	\$ 14.750	\$ 280.250	+ shipping - see freight notes	#REF!
#REF!	Track & Field	9	17	HURDLE CARTS/FIELD WAGONS - 2 Wheeled Hurdle Cart - TH2WD	Stackhouse	TH2WD	EACH	\$ 485.000	5.0%	\$ 24.250	\$ 460.750	+ shipping - see freight notes	#REF!
#REF!	Track & Field	9	17	HURDLE CARTS/FIELD WAGONS - Field Wagon - 1,000 lb. Capacity - 5' x 10' - TFFW510	Stackhouse	TFFW510	EACH	\$ 1,895.000	5.0%	\$ 94.750	\$ 1,800.250	+ shipping - see freight notes	#REF!
#REF!	Track & Field	9	17	HURDLE CARTS/FIELD WAGONS - Adjustable Height Training Hurdle - TAJDH	Stackhouse	TAJDH	EACH	\$ 45.000	5.0%	\$ 2.250	\$ 42.750	+ shipping - see freight notes	#REF!
#REF!	Track & Field	9	18	STARTING BLOCKS - Championship Starting Block - TCHAMP	Stackhouse	TCHAMP	EACH	\$ 130.000	5.0%	\$ 6.500	\$ 123.500	+ shipping - see freight notes	#REF!
#REF!	Track & Field	9	18	STARTING BLOCKS - Cheetah Elite Aluminum Starting Block - TCEB	Stackhouse	TCEB	EACH	\$ 185.000	5.0%	\$ 9.250	\$ 175.750	+ shipping - see freight notes	#REF!
#REF!	Track & Field	9	18	STARTING BLOCKS - Olympia Adjustable Starting Block - TOLY	Stackhouse	TOLY	EACH	\$ 75.000	5.0%	\$ 3.750	\$ 71.250	+ shipping - see freight notes	#REF!
#REF!	Track & Field	9	18	STARTING BLOCKS - Speed Star Starting Block - TSTAR	Stackhouse	TSTAR	EACH	\$ 75.000	5.0%	\$ 3.750	\$ 71.250	+ shipping - see freight notes	#REF!
#REF!	Track & Field	9	18	STARTING BLOCKS - Indoor Starting Blocks (pair) - TISB	Stackhouse	TISB	PAIR	\$ 32.000	5.0%	\$ 1.600	\$ 30.400	+ shipping - see freight notes	#REF!
#REF!	Track & Field	9	18	STARTING BLOCKS - Heavy Duty Starting Block Cart - TSBC2	Stackhouse	TSBC2	EACH	\$ 849.000	5.0%	\$ 42.450	\$ 806.550	+ shipping - see freight notes	#REF!

Bidding Company Name:				Partac Peat Corporation	Catalog Name:		9 - Running Tracks / Shot Put Sector Surfacing / Long Jump Pits						
No.	Product Category	Beam Clay Catalog Section #	Page#	Product Description	Manufacturer	Vendor SKU	Unit of Measure	Catalog List Price	Bid Discount Percentage	Discount Amt.	Net Effective Bid Price	Comments	No.
#REF!	Track & Field	9	18	STARTING BLOCKS - Starting Block Cart -TSECON	Stackhouse	TSECON	EACH	\$ 285.000	5.0%	\$ 14.250	\$ 270.750	+ shipping - see freight notes	#REF!
#REF!	Track & Field	9	19	STARTING BLOCKS - Cantabrian Gran Prix Starting Block - College/Elite High Schools - TCGP	Stackhouse	TCGP	EACH	\$ 425.000	5.0%	\$ 21.250	\$ 403.750	+ shipping - see freight notes	#REF!
#REF!	Track & Field	9	19	STARTING BLOCKS - Cantabrian Catapult Starting Block - TCCAT	Stackhouse	TCCAT	EACH	\$ 285.000	5.0%	\$ 14.250	\$ 270.750	+ shipping - see freight notes	#REF!
#REF!	Track & Field	9	19	STARTING BLOCKS - Newton International "BEST" "The Real Thing!" - T1008	Stackhouse	T1008	EACH	\$ 385.000	5.0%	\$ 19.250	\$ 365.750	+ shipping - see freight notes	#REF!
#REF!	Track & Field	9	19	STARTING BLOCKS - Newton Elite "Better" - T1007	Stackhouse	T1007	EACH	\$ 245.000	5.0%	\$ 12.250	\$ 232.750	+ shipping - see freight notes	#REF!
#REF!	Track & Field	9	20	STARTING BLOCKS - Olympic Pro Starting Block - SBPRO	TSI	SBPRO	EACH	\$ 265.000	5.0%	\$ 13.250	\$ 251.750	+ shipping - see freight notes	#REF!
#REF!	Track & Field	9	20	STARTING BLOCKS - Olympic Stadium Starting Block - SBSTAD	TSI	SBSTAD	EACH	\$ 215.000	5.0%	\$ 10.750	\$ 204.250	+ shipping - see freight notes	#REF!
#REF!	Track & Field	9	20	STARTING BLOCKS - Olympic Elite Aluminum Starting Block - SBELITE	TSI	SBELITE	EACH	\$ 145.000	5.0%	\$ 7.250	\$ 137.750	+ shipping - see freight notes	#REF!
#REF!	Track & Field	9	24	WEIGHTED LONG JUMP PIT COVERS - 18 oz. Solid Vinyl With Heat-Sealed Hem 12' x 28' - WWLJPC18OZ12X28	Humphreys	WWLJPC18OZ12X28	EACH	\$ 600.000	5.0%	\$ 30.000	\$ 570.000	+ shipping - see freight notes	#REF!
#REF!	Track & Field	9	24	WEIGHTED LONG JUMP PIT COVERS - 18 oz. Solid Vinyl With Heat-Sealed Hem 12' x 30' - WWLJPC18OZ12X30	Humphreys	WWLJPC18OZ12X30	EACH	\$ 640.000	5.0%	\$ 32.000	\$ 608.000	+ shipping - see freight notes	#REF!
#REF!	Track & Field	9	24	WEIGHTED LONG JUMP PIT COVERS - 18 oz. Solid Vinyl With Heat-Sealed Hem 12' x 32' - WWLJPC18OZ12X32	Humphreys	WWLJPC18OZ12X32	EACH	\$ 675.000	5.0%	\$ 33.750	\$ 641.250	+ shipping - see freight notes	#REF!
#REF!	Track & Field	9	24	WEIGHTED LONG JUMP PIT COVERS - 18 oz. Solid Vinyl With Heat-Sealed Hem 12' x 34' - WWLJPC18OZ12X34	Humphreys	WWLJPC18OZ12X34	EACH	\$ 710.000	5.0%	\$ 35.500	\$ 674.500	+ shipping - see freight notes	#REF!
#REF!	Track & Field	9	24	WEIGHTED LONG JUMP PIT COVERS - 18 oz. Solid Vinyl With Heat-Sealed Hem CUSTOM SIZE - WWLJPC18OZC	Humphreys	WWLJPC18OZC	SF	\$ 2.080	5.0%	\$ 0.104	\$ 1.976	+ shipping - see freight notes	#REF!
#REF!	Track & Field	9	24	WEIGHTED LONG JUMP PIT COVERS - 14 oz. Premium ArmorMesh With Heat-Sealed Hem 12' X 28' - WWLJPCAM12X28	Humphreys	WWLJPCAM12X28	EACH	\$ 525.000	5.0%	\$ 26.250	\$ 498.750	+ shipping - see freight notes	#REF!
#REF!	Track & Field	9	24	WEIGHTED LONG JUMP PIT COVERS - 14 oz. Premium ArmorMesh With Heat-Sealed Hem 12' X 30' - WWLJPCAM12X30	Humphreys	WWLJPCAM12X30	EACH	\$ 565.000	5.0%	\$ 28.250	\$ 536.750	+ shipping - see freight notes	#REF!
#REF!	Track & Field	9	24	WEIGHTED LONG JUMP PIT COVERS - 14 oz. Premium ArmorMesh With Heat-Sealed Hem 12' X 32' - WWLJPCAM12X32	Humphreys	WWLJPCAM12X32	EACH	\$ 590.000	5.0%	\$ 29.500	\$ 560.500	+ shipping - see freight notes	#REF!
#REF!	Track & Field	9	24	WEIGHTED LONG JUMP PIT COVERS - 14 oz. Premium ArmorMesh With Heat-Sealed Hem 12' X 34' - WWLJPCAM12X34	Humphreys	WWLJPCAM12X34	EACH	\$ 630.000	5.0%	\$ 31.500	\$ 598.500	+ shipping - see freight notes	#REF!
#REF!	Track & Field	9	24	WEIGHTED LONG JUMP PIT COVERS - 14 oz. Premium ArmorMesh With Heat-Sealed Hem CUSTOM SIZE - WWLJPCAMC	Humphreys	WWLJPCAMC	SF	\$ 1.880	5.0%	\$ 0.094	\$ 1.786	+ shipping - see freight notes	#REF!
#REF!	Track & Field	9	24	WEIGHTED LONG JUMP PIT COVERS - 6 oz. Solid Silver/White Polyethylene with Sewn Hem 12' X 28' - WWLJPC6OZ12X28	Humphreys	WWLJPC6OZ12X28	EACH	\$ 385.000	5.0%	\$ 19.250	\$ 365.750	+ shipping - see freight notes	#REF!
#REF!	Track & Field	9	24	WEIGHTED LONG JUMP PIT COVERS - 6 oz. Solid Silver/White Polyethylene with Sewn Hem 12' X 30' - WWLJPC6OZ12X30	Humphreys	WWLJPC6OZ12X30	EACH	\$ 410.000	5.0%	\$ 20.500	\$ 389.500	+ shipping - see freight notes	#REF!
#REF!	Track & Field	9	24	WEIGHTED LONG JUMP PIT COVERS - 6 oz. Solid Silver/White Polyethylene with Sewn Hem 12' X 32' - WWLJPC6OZ12X32	Humphreys	WWLJPC6OZ12X32	EACH	\$ 425.000	5.0%	\$ 21.250	\$ 403.750	+ shipping - see freight notes	#REF!
#REF!	Track & Field	9	25	WEIGHTED LONG JUMP PIT COVERS - 6 oz. Solid Silver/White Polyethylene with Sewn Hem 12' X 34' - WWLJPC6OZ12X34	Humphreys	WWLJPC6OZ12X34	EACH	\$ 435.000	5.0%	\$ 21.750	\$ 413.250	+ shipping - see freight notes	#REF!
#REF!	Track & Field	9	24	WEIGHTED LONG JUMP PIT COVERS - 6 oz. Solid Silver/White Polyethylene with Sewn Hem CUSTOM SIZE - WWLJPC6OZC	Humphreys	WWLJPC6OZC	SF	\$ 1.310	5.0%	\$ 0.066	\$ 1.245	+ shipping - see freight notes	#REF!
#REF!	Track & Field	9	24	LETTERING & NUMBERS - 42" HIGH ONE OR MULTI-COLORED LETTER - LTRS/#42C	Humphreys	LTRS/#42C	EACH	\$ 70.000	5.0%	\$ 3.500	\$ 66.500	+ shipping - see freight notes	#REF!
#REF!	Track & Field	9	24	LETTERING & NUMBERS - 48" HIGH ONE OR MULTI-COLORED LETTER - LTRS/#48C	Humphreys	LTRS/#48C	EACH	\$ 81.000	5.0%	\$ 4.050	\$ 76.950	+ shipping - see freight notes	#REF!

Bidding Company Name:				Partac Peat Corporation	Catalog Name:		9 - Running Tracks / Shot Put Sector Surfacing / Long Jump Pits						
No.	Product Category	Beam Clay Catalog Section #	Page#	Product Description	Manufacturer	Vendor SKU	Unit of Measure	Catalog List Price	Bid Discount Percentage	Discount Amt.	Net Effective Bid Price	Comments	No.
#REF!	Track & Field	9	24	LETTERING & NUMBERS - 54" HIGH ONE OR MULTI-COLORED LETTER - LTRS/#54C	Humphreys	LTRS/#54C	EACH	\$ 94.000	5.0%	\$ 4.700	\$ 89.300	+ shipping - see freight notes	#REF!
#REF!	Track & Field	9	24	LETTERING & NUMBERS - 60" HIGH ONE OR MULTI-COLORED LETTER - LTRS/#60C	Humphreys	LTRS/#60C	EACH	\$ 108.000	5.0%	\$ 5.400	\$ 102.600	+ shipping - see freight notes	#REF!
#REF!	Track & Field	9	24	LETTERING & NUMBERS - MINIMUM ONE OR MULTI-COLORED LETTER - LTRS/#MINC	Humphreys	LTRS/#MINC	EACH	\$ 275.000	5.0%	\$ 13.750	\$ 261.250	+ shipping - see freight notes	#REF!
#REF!	Track & Field	9	24	CUSTOM LOGOS/MULTI-COLORED IMAGES - ONE OR MULTI-COLORED IMAGE UP TO 15 SF (EX. 3' X 5') - LOGOS-C-15SF	Humphreys	LOGOS-C-15SF	EACH	\$ 275.000	5.0%	\$ 13.750	\$ 261.250	+ shipping - see freight notes	#REF!
#REF!	Track & Field	9	24	CUSTOM LOGOS/MULTI-COLORED IMAGES - ONE OR MULTI-COLORED IMAGE UP TO 30 SF (EX. 5' X 6') - LOGOS-C-30SF	Humphreys	LOGOS-C-30SF	EACH	\$ 375.000	5.0%	\$ 18.750	\$ 356.250	+ shipping - see freight notes	#REF!
#REF!	Track & Field	9	24	CUSTOM LOGOS/MULTI-COLORED IMAGES-ONE OR MULTI-COLORED IMAGE UP TO 50 SF(EX. 5' X 10') - LOGOS-C-50SF	Humphreys	LOGOS-C-50SF	EACH	\$ 535.000	5.0%	\$ 26.750	\$ 508.250	+ shipping - see freight notes	#REF!
#REF!	Track & Field	9	24	CUSTOM LOGOS/MULTI-COLORED IMAGES-ONE OR MULTI-COLORED IMAGE UP TO 100 SF(EX. 10' X 10') - LOGOS-C-100SF	Humphreys	LOGOS-C-100SF	EACH	\$ 965.000	5.0%	\$ 48.250	\$ 916.750	+ shipping - see freight notes	#REF!
#REF!	Track & Field	9	25	TAKE-OFF & TOE BOARDS - Tray System - TTSS	Stackhouse	TTSS	EACH	\$ 625.000	5.0%	\$ 31.250	\$ 593.750	+ shipping - see freight notes	#REF!
#REF!	Track & Field	9	25	TAKE-OFF & TOE BOARDS - Poly High School Take-Off Board - TPOLYTB	Stackhouse	TPOLYTB	EACH	\$ 315.000	5.0%	\$ 15.750	\$ 299.250	+ shipping - see freight notes	#REF!
#REF!	Track & Field	9	25	TAKE-OFF & TOE BOARDS - Tray for Poly High School Take-Off Board - THSTBT	Stackhouse	THSTBT	EACH	\$ 439.000	5.0%	\$ 21.950	\$ 417.050	+ shipping - see freight notes	#REF!
#REF!	Track & Field	9	25	TAKE-OFF & TOE BOARDS - International Tak-Off Tray System - TTICS	Stackhouse	TTICS	EACH	\$ 1,275.000	5.0%	\$ 63.750	\$ 1,211.250	+ shipping - see freight notes	#REF!
#REF!	Track & Field	9	25	TAKE-OFF & TOE BOARDS - Long-Jump Triple Jump Take-Off Board - TLT	Stackhouse	TLT	EACH	\$ 229.000	5.0%	\$ 11.450	\$ 217.550	+ shipping - see freight notes	#REF!
#REF!	Track & Field	9	25	TAKE-OFF & TOE BOARDS - Poly Toe Board - TPTB	Stackhouse	TPTB	EACH	\$ 349.000	5.0%	\$ 17.450	\$ 331.550	+ shipping - see freight notes	#REF!
#REF!	Track & Field	9	25	TAKE-OFF & TOE BOARDS - Cast Aluminum Toe Board - For Level Pad - TATB	Stackhouse	TATB	EACH	\$ 525.000	5.0%	\$ 26.250	\$ 498.750	+ shipping - see freight notes	#REF!
#REF!	Track & Field	9	25	TAKE-OFF & TOE BOARDS - Cast Aluminum Toe Board - For Depressed Pad - TATB-DP	Stackhouse	TATB-DP	EACH	\$ 525.000	5.0%	\$ 26.250	\$ 498.750	+ shipping - see freight notes	#REF!
#REF!	Track & Field	9	25	ALL METAL SHOT TOE BOARD	Stackhouse	TMTB	EACH	\$ 239.000	5.0%	\$ 11.950	\$ 227.050	+ shipping - see freight notes	#REF!
#REF!	Track & Field	9	30	HIGH JUMP STANDARDS - Cantabrian Elite International Rollway High Jump Standards - TCEIR	Stackhouse	TCEIR	EACH	\$ 1,039.000	5.0%	\$ 51.950	\$ 987.050	+ shipping - see freight notes	#REF!
#REF!	Track & Field	9	30	HIGH JUMP STANDARDS - Cantabrian Aluminum Rollway High Jump Standards - (Pair) - TRASC	Stackhouse	TRASC	PAIR	\$ 739.000	5.0%	\$ 36.950	\$ 702.050	+ shipping - see freight notes	#REF!
#REF!	Track & Field	9	31	HIGH JUMP STANDARDS - Budget High Jump Standard- (Pair) - TBS	Stackhouse	TBS	PAIR	\$ 229.000	5.0%	\$ 11.450	\$ 217.550	+ shipping - see freight notes	#REF!
#REF!	Track & Field	9	31	HIGH JUMP STANDARDS - Excelsior High Jump Standard- (Pair) - TEXS	Stackhouse	TEXS	PAIR	\$ 425.000	5.0%	\$ 21.250	\$ 403.750	+ shipping - see freight notes	#REF!
#REF!	Track & Field	9	31	HIGH JUMP STANDARDS - Steel Roll Away High Jump Standard- (Pair) - TRSS	Stackhouse	TRSS	PAIR	\$ 659.000	5.0%	\$ 32.950	\$ 626.050	+ shipping - see freight notes	#REF!
#REF!	Track & Field	9	31	HIGH JUMP STANDARDS - Premier High Jump Standard- (Pair) - TOHJS	Stackhouse	TOHJS	PAIR	\$ 959.000	5.0%	\$ 47.950	\$ 911.050	+ shipping - see freight notes	#REF!
#REF!	Track & Field	9	32	HIGH JUMP & POLE VAULT ACCESSORIES - Official Fiberglass Crossbar - 13' 1 1/2" Competition - TFG13-1	Stackhouse	TFG13-1	EACH	\$ 110.000	5.0%	\$ 5.500	\$ 104.500	+ shipping - see freight notes	#REF!
#REF!	Track & Field	9	32	HIGH JUMP & POLE VAULT ACCESSORIES - Official Fiberglass Crossbar - 14' 10" Competition - TFG14-1	Stackhouse	TFG14-1	EACH	\$ 115.000	5.0%	\$ 5.750	\$ 109.250	+ shipping - see freight notes	#REF!
#REF!	Track & Field	9	32	HIGH JUMP & POLE VAULT ACCESSORIES - Official Fiberglass Crossbar - 13' 1/12" Practice - TFP-13	Stackhouse	TFP-13	EACH	\$ 95.000	5.0%	\$ 4.750	\$ 90.250	+ shipping - see freight notes	#REF!

Bidding Company Name:				Partac Peat Corporation	Catalog Name:		9 - Running Tracks / Shot Put Sector Surfacing / Long Jump Pits						
No.	Product Category	Beam Clay Catalog Section #	Page#	Product Description	Manufacturer	Vendor SKU	Unit of Measure	Catalog List Price	Bid Discount Percentage	Discount Amt.	Net Effective Bid Price	Comments	No.
#REF!	Track & Field	9	32	HIGH JUMP & POLE VAULT ACCESSORIES - Official Fiberglass Crossbar - 14' 10" Practice - TFP-14	Stackhouse	TFP-14	EACH	\$ 99.000	5.0%	\$ 4.950	\$ 94.050	+ shipping - see freight notes	#REF!
#REF!	Track & Field	9	32	HIGH JUMP & POLE VAULT ACCESSORIES - Elastic Practice Crossbar - TEPCB	Stackhouse	TEPCB	EACH	\$ 30.000	5.0%	\$ 1.500	\$ 28.500	+ shipping - see freight notes	#REF!
#REF!	Track & Field	9	32	HIGH JUMP & POLE VAULT ACCESSORIES - Nylon Break Away Crossbar for High Jumper - TNTC	Stackhouse	TNTC	EACH	\$ 40.000	5.0%	\$ 2.000	\$ 38.000	+ shipping - see freight notes	#REF!
#REF!	Track & Field	9	32	HIGH JUMP & POLE VAULT ACCESSORIES - High Jump Measure - THJM	Stackhouse	THJM	EACH	\$ 285.000	5.0%	\$ 14.250	\$ 270.750	+ shipping - see freight notes	#REF!
#REF!	Track & Field	9	32	HIGH JUMP & POLE VAULT ACCESSORIES - Pole Vault Measure - TPVM	Stackhouse	TPVM	EACH	\$ 315.000	5.0%	\$ 15.750	\$ 299.250	+ shipping - see freight notes	#REF!
#REF!	Track & Field	9	32	HIGH JUMP & POLE VAULT ACCESSORIES - Adjustable Crossbar Lifter - Extends Crossbar to 15'6" - TACL	Stackhouse	TACL	EACH	\$ 185.000	5.0%	\$ 9.250	\$ 175.750	+ shipping - see freight notes	#REF!
#REF!	Track & Field	9	32	HIGH JUMP & POLE VAULT ACCESSORIES - Crossbar Center Lifter - TCBCCL	Stackhouse	TCBCCL	EACH	\$ 85.000	5.0%	\$ 4.250	\$ 80.750	+ shipping - see freight notes	#REF!
#REF!	Track & Field	9	32	HIGH JUMP & POLE VAULT ACCESSORIES - Crossbar End Lifter - TCBEL	Stackhouse	TCBEL	EACH	\$ 85.000	5.0%	\$ 4.250	\$ 80.750	+ shipping - see freight notes	#REF!
#REF!	Track & Field	9	37	VAULT BOXES - Stainless Steel Vault Box - TSSVB	Stackhouse	TSSVB	EACH	\$ 739.000	5.0%	\$ 36.950	\$ 702.050	+ shipping - see freight notes	#REF!
#REF!	Track & Field	9	37	VAULT BOXES - Steel Lid for Stainless Steel Vault Box - TSVBL	Stackhouse	TSVBL	EACH	\$ 315.000	5.0%	\$ 15.750	\$ 299.250	+ shipping - see freight notes	#REF!
#REF!	Track & Field	9	37	VAULT BOXES - Steel Vault Box - TSVB	Stackhouse	TSVB	EACH	\$ 359.000	5.0%	\$ 17.950	\$ 341.050	+ shipping - see freight notes	#REF!
#REF!	Track & Field	9	37	VAULT BOXES - Steel Lid for Steel Vault Box - TSVBL	Stackhouse	TSVBL	EACH	\$ 315.000	5.0%	\$ 15.750	\$ 299.250	+ shipping - see freight notes	#REF!
#REF!	Track & Field	9	37	VAULT BOXES - Welded Aluminum Vault Box - TWAVB	Stackhouse	TWAVB	EACH	\$ 479.000	5.0%	\$ 23.950	\$ 455.050	+ shipping - see freight notes	#REF!
#REF!	Track & Field	9	37	VAULT BOXES - Aluminum Lid for Welded Aluminum Vault Box - TWAVBL	Stackhouse	TWAVBL	EACH	\$ 455.000	5.0%	\$ 22.750	\$ 432.250	+ shipping - see freight notes	#REF!
#REF!	Track & Field	9	37	VAULT BOXES - Cast Aluminum Vault Box - TCAVB	Stackhouse	TCAVB	EACH	\$ 775.000	5.0%	\$ 38.750	\$ 736.250	+ shipping - see freight notes	#REF!
#REF!	Track & Field	9	37	VAULT BOXES - Cast Aluminum Lid for Cast Aluminum Vault Box - TCAVBL	Stackhouse	TCAVBL	EACH	\$ 385.000	5.0%	\$ 19.250	\$ 365.750	+ shipping - see freight notes	#REF!
#REF!	Track & Field	9	37	VAULT BOXES - Pole Vault Slide Box - TPVSB	Stackhouse	TPVSB	EACH	\$ 465.000	5.0%	\$ 23.250	\$ 441.750	+ shipping - see freight notes	#REF!
#REF!	Track & Field	9	38	VALUE PACKS & POLE ACCESSORIES - Vault Protective Padding - TVP	Stackhouse	TVP	EACH	\$ 415.000	5.0%	\$ 20.750	\$ 394.250	+ shipping - see freight notes	#REF!
#REF!	Track & Field	9	38	VALUE PACKS & POLE ACCESSORIES - Vault Box Collar - TVC	Stackhouse	TVC	EACH	\$ 645.000	5.0%	\$ 32.250	\$ 612.750	+ shipping - see freight notes	#REF!
#REF!	Track & Field	9	38	VALUE PACKS & POLE ACCESSORIES - Weather Cover Insert - TWCI	Stackhouse	TWCI	EACH	\$ 49.000	5.0%	\$ 2.450	\$ 46.550	+ shipping - see freight notes	#REF!
#REF!	Track & Field	9	38	VALUE PACKS & POLE ACCESSORIES - High School Boy's Throws Value Pack - TTP-B	Stackhouse	TTP-B	EACH	\$ 250.000	5.0%	\$ 12.500	\$ 237.500	+ shipping - see freight notes	#REF!
#REF!	Track & Field	9	38	VALUE PACKS & POLE ACCESSORIES - High School Girl's Throws Value Pack - TTP-G	Stackhouse	TTP-G	EACH	\$ 235.000	5.0%	\$ 11.750	\$ 223.250	+ shipping - see freight notes	#REF!
#REF!	Track & Field	9	39	POLE VAULT STANDARDS - Pole Vault Standards - Pair - TPV56	Stackhouse	TPV56	PAIR	\$ 1,150.000	5.0%	\$ 57.500	\$ 1,092.500	+ shipping - see freight notes	#REF!
#REF!	Track & Field	9	39	POLE VAULT STANDARDS - Pole Vault Standards - Universal 3' Extension - Pair - TPV5EU	Stackhouse	TPV5EU	PAIR	\$ 205.000	5.0%	\$ 10.250	\$ 194.750	+ shipping - see freight notes	#REF!
#REF!	Track & Field	9	39	POLE VAULT STANDARDS - Premier Aluminum Pole Vault Standards - Pair - TOPVS	Stackhouse	TOPVS	PAIR	\$ 2,495.000	5.0%	\$ 124.750	\$ 2,370.250	+ shipping - see freight notes	#REF!

Bidding Company Name:				Partac Peat Corporation	Catalog Name:		9 - Running Tracks / Shot Put Sector Surfacing / Long Jump Pits						
No.	Product Category	Beam Clay Catalog Section #	Page#	Product Description	Manufacturer	Vendor SKU	Unit of Measure	Catalog List Price	Bid Discount Percentage	Discount Amt.	Net Effective Bid Price	Comments	No.
#REF!	Track & Field	9	39	POLE VAULT STANDARDS - Premier 3' Extensions - Pair - TPVSEO	Stackhouse	TPVSEO	PAIR	\$ 170.000	5.0%	\$ 8.500	\$ 161.500	+ shipping - see freight notes	#REF!
#REF!	Track & Field	9	40	POLE VAULT STANDARDS - Cantabrian Pole Vault Standards - Pair - TCPVS	Stackhouse	TCPVS	PAIR	\$ 3,150.000	5.0%	\$ 157.500	\$ 2,992.500	+ shipping - see freight notes	#REF!
#REF!	Track & Field	9	40	POLE VAULT STANDARDS - Cantabrian International Crossbars - 13' 1 1/2" High Jump Crossbar - TCFHJ13	Stackhouse	TCFHJ13	EACH	\$ 139.000	5.0%	\$ 6.950	\$ 132.050	+ shipping - see freight notes	#REF!
#REF!	Track & Field	9	40	Replacement Crossbar End - International/College TCEND	Stackhouse	TCEND	EACH	\$ 17.000	5.0%	\$ 0.850	\$ 16.150	+ shipping - see freight notes	#REF!
#REF!	Track & Field	9	40	POLE VAULT STANDARDS - Cantabrian International Crossbars - 14' 10" Pole Vault Crossbar - TCPV14	Stackhouse	TCPV14	EACH	\$ 155.000	5.0%	\$ 7.750	\$ 147.250	+ shipping - see freight notes	#REF!
#REF!	Track & Field	9	41	SHOT PUT THROWING SECTOR SURFACES - 3/16" Burgundy Red with 5% Beam Clay Red Binder - BULK #SP-R5 BULK	Partac Peat Corporation	SP-R5 BULK	TON	\$ 60.000	5.0%	\$ 3.000	\$ 57.000	+ shipping - see freight notes	#REF!
#REF!	Track & Field	9	41	SHOT PUT THROWING SECTOR SURFACES - 3/16" Burgundy Red with 5% Beam Clay Red Binder - 50 LB. BAG #SP-R5 BAG	Partac Peat Corporation	SP-R5 BAG	50 LB BAG	\$ 6.500	5.0%	\$ 0.325	\$ 6.175	+ shipping - see freight notes	#REF!
#REF!	Track & Field	9	41	SHOT PUT THROWING SECTOR SURFACES - 3/16" Burgundy Red with 20% Beam Clay Red Binder - BULK #SP-R20 BULK	Partac Peat Corporation	SP-R20 BULK	TON	\$ 90.000	5.0%	\$ 4.500	\$ 85.500	+ shipping - see freight notes	#REF!
#REF!	Track & Field	9	41	SHOT PUT THROWING SECTOR SURFACES - 3/16" Burgundy Red with 20% Beam Clay Red Binder - 50 LB. BAG #SP-R20 BAG	Partac Peat Corporation	SP-R20 BAG	50 LB BAG	\$ 7.250	5.0%	\$ 0.363	\$ 6.888	+ shipping - see freight notes	#REF!
#REF!	Track & Field	9	41	SHOT PUT THROWING SECTOR SURFACES - 3/16" Grey with 5% Beam Clay Grey Binder - BULK #SP-G5 BULK	Partac Peat Corporation	SP-G5 BULK	TON	\$ 60.000	5.0%	\$ 3.000	\$ 57.000	+ shipping - see freight notes	#REF!
#REF!	Track & Field	9	41	SHOT PUT THROWING SECTOR SURFACES - 3/16" Grey with 5% Beam Clay Grey Binder - 50 LB. BAG #SP-G5 BAG	Partac Peat Corporation	SP-G5 BAG	50 LB BAG	\$ 6.750	5.0%	\$ 0.338	\$ 6.413	+ shipping - see freight notes	#REF!
#REF!	Track & Field	9	41	SHOT PUT THROWING SECTOR SURFACES - 3/16" Grey with 20% Beam Clay Grey Binder - BULK #SP-G20 BULK	Partac Peat Corporation	SP-G20 BULK	TON	\$ 90.000	5.0%	\$ 4.500	\$ 85.500	+ shipping - see freight notes	#REF!
#REF!	Track & Field	9	41	SHOT PUT THROWING SECTOR SURFACES - 3/16" Grey with 20% Beam Clay Grey Binder - 50 LB BAG - #SP-G20 BAG	Partac Peat Corporation	SP-G20 BAG	50 LB BAG	\$ 7.500	5.0%	\$ 0.375	\$ 7.125	+ shipping - see freight notes	#REF!
#REF!	Track & Field	9	41	SHOT PUT THROWING SECTOR SURFACES - 3/16" Black with 5% Beam Clay Black Binder - BULK #SP-B5 BULK	Partac Peat Corporation	SP-B5 BULK	TON	\$ 60.000	5.0%	\$ 3.000	\$ 57.000	+ shipping - see freight notes	#REF!
#REF!	Track & Field	9	41	SHOT PUT THROWING SECTOR SURFACES - 3/16" Black with 5% Beam Clay Black Binder - 50 LB. BAG #SP-B5 BAG	Partac Peat Corporation	SP-B5 BAG	50 LB BAG	\$ 6.750	5.0%	\$ 0.338	\$ 6.413	+ shipping - see freight notes	#REF!
#REF!	Track & Field	9	41	SHOT PUT THROWING SECTOR SURFACES - 3/16" Black with 20% Beam Clay Black Binder - BULK #SP-B20 BULK	Partac Peat Corporation	SP-B20 BULK	TON	\$ 90.000	5.0%	\$ 4.500	\$ 85.500	+ shipping - see freight notes	#REF!
#REF!	Track & Field	9	41	SHOT PUT THROWING SECTOR SURFACES - 3/16" Black with 20% Beam Clay Black Binder - 50 LB BAG - #SP-B20 BAG	Partac Peat Corporation	SP-B20 BAG	50 LB BAG	\$ 7.500	5.0%	\$ 0.375	\$ 7.125	+ shipping - see freight notes	#REF!
#REF!	Track & Field	9	41	SHOT PUT THROWING SECTOR SURFACES - 3/16" White with 5% Beam Clay White Binder - BULK #SP-W5 BULK	Partac Peat Corporation	SP-W5 BULK	TON	\$ 60.000	5.0%	\$ 3.000	\$ 57.000	+ shipping - see freight notes	#REF!
#REF!	Track & Field	9	41	SHOT PUT THROWING SECTOR SURFACES - 3/16" White with 5% Beam Clay White Binder - 50 LB. BAG #SP-W5 BAG	Partac Peat Corporation	SP-W5 BAG	50 LB BAG	\$ 6.750	5.0%	\$ 0.338	\$ 6.413	+ shipping - see freight notes	#REF!
#REF!	Track & Field	9	41	SHOT PUT THROWING SECTOR SURFACES - 3/16" White with 20% Beam Clay White Binder - BULK #SP-W20 BULK	Partac Peat Corporation	SP-W20 BULK	TON	\$ 90.000	5.0%	\$ 4.500	\$ 85.500	+ shipping - see freight notes	#REF!
#REF!	Track & Field	9	41	SHOT PUT THROWING SECTOR SURFACES - 3/16" White with 20% Beam Clay White Binder - 50 LB BAG - #SP-W20 BAG	Partac Peat Corporation	SP-WG20 BAG	50 LB BAG	\$ 7.500	5.0%	\$ 0.375	\$ 7.125	+ shipping - see freight notes	#REF!
#REF!	Track & Field	9	41	SHOT PUT THROWING SECTOR SURFACES - 3/16" Tan with 5% Beam Clay Tan Binder - BULK #SP-T5 BULK	Partac Peat Corporation	SP-T5 BULK	BULK	\$ 80.000	5.0%	\$ 4.000	\$ 76.000	+ shipping - see freight notes	#REF!
#REF!	Track & Field	9	41	SHOT PUT THROWING SECTOR SURFACES - 3/16" Tan with 5% Beam Clay Tan Binder - 50 LB BAG #SP-T5 BAG	Partac Peat Corporation	SP-T5 BAG	50 LB BAG	\$ 8.000	5.0%	\$ 0.400	\$ 7.600	+ shipping - see freight notes	#REF!
#REF!	Track & Field	9	41	SHOT PUT THROWING SECTOR SURFACES - 3/16" Tan with 20% Beam Clay Tan Binder - BULK #SP-T20 BULK	Partac Peat Corporation	SP-T20 BULK	TON	\$ 110.000	5.0%	\$ 5.500	\$ 104.500	+ shipping - see freight notes	#REF!
#REF!	Track & Field	9	41	SHOT PUT THROWING SECTOR SURFACES - 3/16" Tan with 20% Beam Clay Tan Binder - 50 LB BAG #SP-T20 BAG	Partac Peat Corporation	SP-T20 BAG	50 LB BAG	\$ 8.750	5.0%	\$ 0.438	\$ 8.313	+ shipping - see freight notes	#REF!

Bidding Company Name:				Partac Peat Corporation	Catalog Name:		9 - Running Tracks / Shot Put Sector Surfacing / Long Jump Pits						
No.	Product Category	Beam Clay Catalog Section #	Page#	Product Description	Manufacturer	Vendor SKU	Unit of Measure	Catalog List Price	Bid Discount Percentage	Discount Amt.	Net Effective Bid Price	Comments	No.
#REF!	Track & Field	9	41	SHOT PUT THROWING SECTOR SURFACES - 3/16" Burgundy Red with Stabilizer Binder - BULK - #SP-RS BULK	Partac Peat Corporation	SP-RS BULK	BULK	\$ 115.000	5.0%	\$ 5.750	\$ 109.250	+ shipping - see freight notes	#REF!
#REF!	Track & Field	9	41	SHOT PUT THROWING SECTOR SURFACES - 3/16" Burgundy Red with Stabilizer Binder - 50 LB. BAG - #SP-RS BAG	Partac Peat Corporation	SP-RS BAG	50 LB BAG	\$ 8.000	5.0%	\$ 0.400	\$ 7.600	+ shipping - see freight notes	#REF!
#REF!	Track & Field	9	41	SHOT PUT THROWING SECTOR SURFACES - 3/16" Grey with Stabilizer* Binder - BULK -# SP-GS BULK	Partac Peat Corporation	SP-GS BULK	BULK	\$ 115.000	5.0%	\$ 5.750	\$ 109.250	+ shipping - see freight notes	#REF!
#REF!	Track & Field	9	41	SHOT PUT THROWING SECTOR SURFACES - 3/16" Grey with Stabilizer* Binder - 50 LB. BAG -# SP-GS BAG	Partac Peat Corporation	SP-GS BAG	50 LB BAG	\$ 8.250	5.0%	\$ 0.413	\$ 7.838	+ shipping - see freight notes	#REF!
#REF!	Track & Field	9	41	SHOT PUT THROWING SECTOR SURFACES - 3/16" Black with Stabilizer* Binder - BULK -# SP-BS BULK	Partac Peat Corporation	SP-BS BULK	BULK	\$ 115.000	5.0%	\$ 5.750	\$ 109.250	+ shipping - see freight notes	#REF!
#REF!	Track & Field	9	41	SHOT PUT THROWING SECTOR SURFACES - 3/16" Black with Stabilizer* Binder - 50 LB. BAG -# SP-BS BAG	Partac Peat Corporation	SP-BS BAG	50 LB BAG	\$ 8.250	5.0%	\$ 0.413	\$ 7.838	+ shipping - see freight notes	#REF!
#REF!	Track & Field	9	41	SHOT PUT THROWING SECTOR SURFACES - 3/16" White with Stabilizer* Binder - BULK -# SP-WS BULK	Partac Peat Corporation	SP-WS BULK	BULK	\$ 115.000	5.0%	\$ 5.750	\$ 109.250	+ shipping - see freight notes	#REF!
#REF!	Track & Field	9	41	SHOT PUT THROWING SECTOR SURFACES - 3/16" White with Stabilizer* Binder - 50 LB. BAG -# SP-WS BAG	Partac Peat Corporation	SP-WS BAG	50 LB BAG	\$ 8.250	5.0%	\$ 0.413	\$ 7.838	+ shipping - see freight notes	#REF!
#REF!	Track & Field	9	41	SHOT PUT THROWING SECTOR SURFACES - 3/16" Tan with Stabilizer* Binder -BULK - # SP-TS BULK	Partac Peat Corporation	SP-TS BULK	BULK	\$ 135.000	5.0%	\$ 6.750	\$ 128.250	+ shipping - see freight notes	#REF!
#REF!	Track & Field	9	41	SHOT PUT THROWING SECTOR SURFACES - 3/16" Tan with Stabilizer* Binder -50 LBS.- # SP-TS BAG	Partac Peat Corporation	SP-TS BAG	50 LB BAG	\$ 9.500	5.0%	\$ 0.475	\$ 9.025	+ shipping - see freight notes	#REF!
#REF!	Track & Field	9	various	FULL OR PARTIAL PALLETS: PALLET & COVER CHARGES FROM NJ	Partac Peat Corporation	NJ-PALLET	EACH	\$ 6.500	5.0%	\$ 0.325	\$ 6.175	+ shipping - see freight notes	#REF!
#REF!	Track & Field	9	42	SHOTS/THROWING WEIGHTS - Competition Iron Shot Puts - Special Olympics - 3 lbs. - TIS3	Stackhouse	TIS3	EACH	\$ 23.000	5.0%	\$ 1.150	\$ 21.850	+ shipping - see freight notes	#REF!
#REF!	Track & Field	9	42	SHOTS/THROWING WEIGHTS - Competition Iron Shot Puts - Special Olympics - 4 lbs. - TIS45	Stackhouse	TIS45	EACH	\$ 27.000	5.0%	\$ 1.350	\$ 25.650	+ shipping - see freight notes	#REF!
#REF!	Track & Field	9	42	SHOTS/THROWING WEIGHTS - Competition Iron Shot Puts - 2 kilos - TIS2	Stackhouse	TIS2	EACH	\$ 26.000	5.0%	\$ 1.300	\$ 24.700	+ shipping - see freight notes	#REF!
#REF!	Track & Field	9	42	SHOTS/THROWING WEIGHTS - Competition Iron Shot Puts - 6 lbs. - TIS6	Stackhouse	TIS6	EACH	\$ 24.000	5.0%	\$ 1.200	\$ 22.800	+ shipping - see freight notes	#REF!
#REF!	Track & Field	9	42	SHOTS/THROWING WEIGHTS - Competition Iron Shot Puts - 3 kilos - Women - TIS3M	Stackhouse	TIS3M	EACH	\$ 26.000	5.0%	\$ 1.300	\$ 24.700	+ shipping - see freight notes	#REF!
#REF!	Track & Field	9	42	SHOTS/THROWING WEIGHTS - Competition Iron Shot Puts - 8 lbs. - TIS8	Stackhouse	TIS8	EACH	\$ 28.000	5.0%	\$ 1.400	\$ 26.600	+ shipping - see freight notes	#REF!
#REF!	Track & Field	9	42	SHOTS/THROWING WEIGHTS - Competition Iron Shot Puts - 4 kilos - TIS4	Stackhouse	TIS4	EACH	\$ 32.000	5.0%	\$ 1.600	\$ 30.400	+ shipping - see freight notes	#REF!
#REF!	Track & Field	9	42	SHOTS/THROWING WEIGHTS - Competition Iron Shot Puts - 10 lbs. - TIS10	Stackhouse	TIS10	EACH	\$ 35.000	5.0%	\$ 1.750	\$ 33.250	+ shipping - see freight notes	#REF!
#REF!	Track & Field	9	42	SHOTS/THROWING WEIGHTS - Competition Iron Shot Puts - 5 kilos. - Men - TISSM	Stackhouse	TISSM	EACH	\$ 37.000	5.0%	\$ 1.850	\$ 35.150	+ shipping - see freight notes	#REF!
#REF!	Track & Field	9	42	SHOTS/THROWING WEIGHTS - Competition Iron Shot Puts - 12 lbs. - TIS12	Stackhouse	TIS12	EACH	\$ 37.000	5.0%	\$ 1.850	\$ 35.150	+ shipping - see freight notes	#REF!
#REF!	Track & Field	9	42	SHOTS/THROWING WEIGHTS - Competition Iron Shot Puts - 6 kilos - Men - TIS6M	Stackhouse	TIS6M	EACH	\$ 45.000	5.0%	\$ 2.250	\$ 42.750	+ shipping - see freight notes	#REF!
#REF!	Track & Field	9	42	SHOTS/THROWING WEIGHTS - Competition Iron Shot Puts - 14 lbs. - TIS14	Stackhouse	TIS14	EACH	\$ 53.000	5.0%	\$ 2.650	\$ 50.350	+ shipping - see freight notes	#REF!
#REF!	Track & Field	9	42	SHOTS/THROWING WEIGHTS - Competition Iron Shot Puts - 16 lbs. - TIS16	Stackhouse	TIS16	EACH	\$ 53.000	5.0%	\$ 2.650	\$ 50.350	+ shipping - see freight notes	#REF!
#REF!	Track & Field	9	42	SHOTS/THROWING WEIGHTS - World Class Shots - 4 kilos - TIWS100	Stackhouse	TIWS100	EACH	\$ 78.000	5.0%	\$ 3.900	\$ 74.100	+ shipping - see freight notes	#REF!

Bidding Company Name:				Partac Peat Corporation	Catalog Name:		9 - Running Tracks / Shot Put Sector Surfacing / Long Jump Pits						
No.	Product Category	Beam Clay Catalog Section #	Page#	Product Description	Manufacturer	Vendor SKU	Unit of Measure	Catalog List Price	Bid Discount Percentage	Discount Amt.	Net Effective Bid Price	Comments	No.
#REF!	Track & Field	9	42	SHOTS/THROWING WEIGHTS - World Class Shots - 4 kilos - TIWS104	Stackhouse	TIWS104	EACH	\$ 64.000	5.0%	\$ 3.200	\$ 60.800	+ shipping - see freight notes	#REF!
#REF!	Track & Field	9	42	SHOTS/THROWING WEIGHTS - World Class Shots - 4 kilos - TIWS108	Stackhouse	TIWS108	EACH	\$ 68.000	5.0%	\$ 3.400	\$ 64.600	+ shipping - see freight notes	#REF!
#REF!	Track & Field	9	42	SHOTS/THROWING WEIGHTS - World Class Shots - 12 lbs. - TIWS112	Stackhouse	TIWS112	EACH	\$ 92.000	5.0%	\$ 4.600	\$ 87.400	+ shipping - see freight notes	#REF!
#REF!	Track & Field	9	42	SHOTS/THROWING WEIGHTS - World Class Shots - 12 lbs. - TIWS115	Stackhouse	TIWS115	EACH	\$ 72.000	5.0%	\$ 3.600	\$ 68.400	+ shipping - see freight notes	#REF!
#REF!	Track & Field	9	42	SHOTS/THROWING WEIGHTS - World Class Shots - 16 lbs. - TIWS120	Stackhouse	TIWS120	EACH	\$ 116.000	5.0%	\$ 5.800	\$ 110.200	+ shipping - see freight notes	#REF!
#REF!	Track & Field	9	42	SHOTS/THROWING WEIGHTS - World Class Shots - 16 lbs. - TIWS125	Stackhouse	TIWS125	EACH	\$ 102.000	5.0%	\$ 5.100	\$ 96.900	+ shipping - see freight notes	#REF!
#REF!	Track & Field	9	42	SHOTS/THROWING WEIGHTS - World Class Shots - 16 lbs. - TIWS128	Stackhouse	TIWS128	EACH	\$ 89.000	5.0%	\$ 4.450	\$ 84.550	+ shipping - see freight notes	#REF!
#REF!	Track & Field	9	42	SHOTS/THROWING WEIGHTS - Turned Steel Shot - 4 kilos - TSS96	Stackhouse	TSS96	EACH	\$ 115.000	5.0%	\$ 5.750	\$ 109.250	+ shipping - see freight notes	#REF!
#REF!	Track & Field	9	42	SHOTS/THROWING WEIGHTS - Turned Steel Shot - 4 kilos - TSS109	Stackhouse	TSS109	EACH	\$ 119.000	5.0%	\$ 5.950	\$ 113.050	+ shipping - see freight notes	#REF!
#REF!	Track & Field	9	42	SHOTS/THROWING WEIGHTS - Turned Steel Shot - 12 lbs. - TSS102	Stackhouse	TSS102	EACH	\$ 115.000	5.0%	\$ 5.750	\$ 109.250	+ shipping - see freight notes	#REF!
#REF!	Track & Field	9	42	SHOTS/THROWING WEIGHTS - Turned Steel Shot - 12 lbs. - TSS110	Stackhouse	TSS110	EACH	\$ 119.000	5.0%	\$ 5.950	\$ 113.050	+ shipping - see freight notes	#REF!
#REF!	Track & Field	9	42	SHOTS/THROWING WEIGHTS - Turned Steel Shot - 12 lbs. - TSS117	Stackhouse	TSS117	EACH	\$ 129.000	5.0%	\$ 6.450	\$ 122.550	+ shipping - see freight notes	#REF!
#REF!	Track & Field	9	42	SHOTS/THROWING WEIGHTS - Turned Steel Shot - 16 lbs. - TSS116	Stackhouse	TSS116	EACH	\$ 119.000	5.0%	\$ 5.950	\$ 113.050	+ shipping - see freight notes	#REF!
#REF!	Track & Field	9	42	SHOTS/THROWING WEIGHTS - Turned Steel Shot - 16 lbs. - TSS129	Stackhouse	TSS129	EACH	\$ 130.000	5.0%	\$ 6.500	\$ 123.500	+ shipping - see freight notes	#REF!
#REF!	Track & Field	9	42	SHOTS/THROWING WEIGHTS - Stainless Steel Shots - 4 kilos - TSP4	Stackhouse	TSP4	EACH	\$ 153.000	5.0%	\$ 7.650	\$ 145.350	+ shipping - see freight notes	#REF!
#REF!	Track & Field	9	42	SHOTS/THROWING WEIGHTS - Stainless Steel Shots - 12 lbs. - TSP12	Stackhouse	TSP12	EACH	\$ 180.000	5.0%	\$ 9.000	\$ 171.000	+ shipping - see freight notes	#REF!
#REF!	Track & Field	9	42	SHOTS/THROWING WEIGHTS - Stainless Steel Shots - 16 lbs. - TSP16	Stackhouse	TSP16	EACH	\$ 197.000	5.0%	\$ 9.850	\$ 187.150	+ shipping - see freight notes	#REF!
#REF!	Track & Field	9	42	SHOTS/THROWING WEIGHTS - Brass Shot Put - 8 lbs. - TB4	Stackhouse	TB4	EACH	\$ 158.000	5.0%	\$ 7.900	\$ 150.100	+ shipping - see freight notes	#REF!
#REF!	Track & Field	9	42	SHOTS/THROWING WEIGHTS - Brass Shot Put - 12 lbs. - TB12	Stackhouse	TB12	EACH	\$ 191.000	5.0%	\$ 9.550	\$ 181.450	+ shipping - see freight notes	#REF!
#REF!	Track & Field	9	42	SHOTS/THROWING WEIGHTS - Brass Shot Put - 16 lbs. - TB16	Stackhouse	TB16	EACH	\$ 208.000	5.0%	\$ 10.400	\$ 197.600	+ shipping - see freight notes	#REF!
#REF!	Track & Field	9	42	SHOTS/THROWING WEIGHTS - Cantabrian Steel Shots - 16 lbs. - TCS129	Stackhouse	TCS129	EACH	\$ 130.000	5.0%	\$ 6.500	\$ 123.500	+ shipping - see freight notes	#REF!
#REF!	Track & Field	9	42	SHOTS/THROWING WEIGHTS - Cantabrian Steel Shots - 12 lbs. - TCS117	Stackhouse	TCS117	EACH	\$ 129.000	5.0%	\$ 6.450	\$ 122.550	+ shipping - see freight notes	#REF!
#REF!	Track & Field	9	42	SHOTS/THROWING WEIGHTS - Cantabrian Steel Shots - 4 kilos. - TCS109	Stackhouse	TCS109	EACH	\$ 115.000	5.0%	\$ 5.750	\$ 109.250	+ shipping - see freight notes	#REF!
#REF!	Track & Field	9	42	SHOTS/THROWING WEIGHTS - Indoor Shots - Soft Shell - 6 lbs. - TSS6	Stackhouse	TSS6	EACH	\$ 75.000	5.0%	\$ 3.750	\$ 71.250	+ shipping - see freight notes	#REF!
#REF!	Track & Field	9	42	SHOTS/THROWING WEIGHTS - Indoor Shots - Soft Shell - 8 lbs. - TSS8	Stackhouse	TSS8	EACH	\$ 85.000	5.0%	\$ 4.250	\$ 80.750	+ shipping - see freight notes	#REF!

Bidding Company Name:				Partac Peat Corporation	Catalog Name:		9 - Running Tracks / Shot Put Sector Surfacing / Long Jump Pits						
No.	Product Category	Beam Clay Catalog Section #	Page#	Product Description	Manufacturer	Vendor SKU	Unit of Measure	Catalog List Price	Bid Discount Percentage	Discount Amt.	Net Effective Bid Price	Comments	No.
#REF!	Track & Field	9	42	SHOTS/THROWING WEIGHTS - Indoor Shots - Soft Shell - 4 kilos. - TSS4	Stackhouse	TSS4	EACH	\$ 85.000	5.0%	\$ 4.250	\$ 80.750	+ shipping - see freight notes	#REF!
#REF!	Track & Field	9	42	SHOTS/THROWING WEIGHTS - Indoor Shots - Soft Shell - 12 lbs.. - TSS12	Stackhouse	TSS12	EACH	\$ 95.000	5.0%	\$ 4.750	\$ 90.250	+ shipping - see freight notes	#REF!
#REF!	Track & Field	9	42	SHOTS/THROWING WEIGHTS - Indoor Shots - Soft Shell - 16 lbs.. - TSS16	Stackhouse	TSS16	EACH	\$ 125.000	5.0%	\$ 6.250	\$ 118.750	+ shipping - see freight notes	#REF!
#REF!	Track & Field	9	42	SHOTS/THROWING WEIGHTS - Indoor Shots - Hard Shell - 6 lbs. - THS6	Stackhouse	THS6	EACH	\$ 80.000	5.0%	\$ 4.000	\$ 76.000	+ shipping - see freight notes	#REF!
#REF!	Track & Field	9	42	SHOTS/THROWING WEIGHTS - Indoor Shots - Hard Shell - 8 lbs. - THS8	Stackhouse	THS8	EACH	\$ 87.000	5.0%	\$ 4.350	\$ 82.650	+ shipping - see freight notes	#REF!
#REF!	Track & Field	9	42	SHOTS/THROWING WEIGHTS - Indoor Shots - Hard Shell - 4 kilos - THS4	Stackhouse	THS4	EACH	\$ 90.000	5.0%	\$ 4.500	\$ 85.500	+ shipping - see freight notes	#REF!
#REF!	Track & Field	9	42	SHOTS/THROWING WEIGHTS - Indoor Shots - Hard Shell - 12 lbs. - THS12	Stackhouse	THS12	EACH	\$ 105.000	5.0%	\$ 5.250	\$ 99.750	+ shipping - see freight notes	#REF!
#REF!	Track & Field	9	42	SHOTS/THROWING WEIGHTS - Indoor Shots - Hard Shell - 16 lbs. - THS16	Stackhouse	THS16	EACH	\$ 135.000	5.0%	\$ 6.750	\$ 128.250	+ shipping - see freight notes	#REF!
#REF!	Track & Field	9	43	HAMMERS - Cantabrian Hammer - Comes with Wire and Handle - 16 lbs. - Black TCSH110	Stackhouse	TCSH110	EACH	\$ 177.000	5.0%	\$ 8.850	\$ 168.150	+ shipping - see freight notes	#REF!
#REF!	Track & Field	9	43	HAMMERS - Cantabrian Hammer - Comes with Wire and Handle - 12 lbs. -Blue TCSH103	Stackhouse	TCSH103	EACH	\$ 165.000	5.0%	\$ 8.250	\$ 156.750	+ shipping - see freight notes	#REF!
#REF!	Track & Field	9	43	HAMMERS - Cantabrian Hammer - Comes with Wire and Handle - 4 K -Pink TCSH95	Stackhouse	TCSH95	EACH	\$ 145.000	5.0%	\$ 7.250	\$ 137.750	+ shipping - see freight notes	#REF!
#REF!	Track & Field	9	43	HAMMERS - Stainless Steel Hammer - Comes with 2mm Wire and Olympic Handle - 4 K - THSS4	Stackhouse	THSS4	EACH	\$ 239.000	5.0%	\$ 11.950	\$ 227.050	+ shipping - see freight notes	#REF!
#REF!	Track & Field	9	43	HAMMERS - Stainless Steel Hammer - Comes with 2mm Wire and Olympic Handle - 12 lbs. - THSS12	Stackhouse	THSS12	EACH	\$ 275.000	5.0%	\$ 13.750	\$ 261.250	+ shipping - see freight notes	#REF!
#REF!	Track & Field	9	43	HAMMERS - Stainless Steel Hammer - Comes with 2mm Wire and Olympic Handle - 16 lbs. - THSS16	Stackhouse	TSS16	EACH	\$ 309.000	5.0%	\$ 15.450	\$ 293.550	+ shipping - see freight notes	#REF!
#REF!	Track & Field	9	43	HAMMERS - Lathe-Turned Iron Hammer - All steel swivel, wire and competition steel handle included - 4 kilos - TIH4	Stackhouse	TIH4	EACH	\$ 83.000	5.0%	\$ 4.150	\$ 78.850	+ shipping - see freight notes	#REF!
#REF!	Track & Field	9	43	HAMMERS - Lathe-Turned Iron Hammer - All steel swivel, wire and competition steel handle included - 5.5 kilos - TIH5.5	Stackhouse	TIH5.5	EACH	\$ 92.000	5.0%	\$ 4.600	\$ 87.400	+ shipping - see freight notes	#REF!
#REF!	Track & Field	9	43	HAMMERS - Lathe-Turned Iron Hammer - All steel swivel, wire and competition steel handle included - 16 lbs. - TIH7	Stackhouse	TIH7	EACH	\$ 99.000	5.0%	\$ 4.950	\$ 94.050	+ shipping - see freight notes	#REF!
#REF!	Track & Field	9	43	HAMMERS - Hammer Wires - All steel swivel, wire and competition steel handle included - 37.5" - TW1	Stackhouse	TW1	EACH	\$ 16.000	5.0%	\$ 0.800	\$ 15.200	+ shipping - see freight notes	#REF!
#REF!	Track & Field	9	43	HAMMERS - Hammer Wires - All steel swivel, wire and competition steel handle included - 38" - TW2	Stackhouse	TW2	EACH	\$ 16.000	5.0%	\$ 0.800	\$ 15.200	+ shipping - see freight notes	#REF!
#REF!	Track & Field	9	43	HAMMERS - Hammer Wires - All steel swivel, wire and competition steel handle included - 38.25" - TW3	Stackhouse	TW3	EACH	\$ 16.000	5.0%	\$ 0.800	\$ 15.200	+ shipping - see freight notes	#REF!
#REF!	Track & Field	9	43	HAMMERS - Hammer Wires - All steel swivel, wire and competition steel handle included - 38.5" - TW4	Stackhouse	TW4	EACH	\$ 16.000	5.0%	\$ 0.800	\$ 15.200	+ shipping - see freight notes	#REF!
#REF!	Track & Field	9	43	HAMMERS - Hammer Wires - All steel swivel, wire and competition steel handle included - 39" - TW5	Stackhouse	TW5	EACH	\$ 16.000	5.0%	\$ 0.800	\$ 15.200	+ shipping - see freight notes	#REF!
#REF!	Track & Field	9	43	HAMMERS - Hammer Wires - All steel swivel, wire and competition steel handle included - 39.5" - TW5.5	Stackhouse	TW5.5	EACH	\$ 16.000	5.0%	\$ 0.800	\$ 15.200	+ shipping - see freight notes	#REF!
#REF!	Track & Field	9	43	HAMMERS - Gloves - Hammer - Has extra wide leather piece over fingers for longer wear and safety - Left Medium - TGLM	Stackhouse	TGLM	EACH	\$ 40.000	5.0%	\$ 2.000	\$ 38.000	+ shipping - see freight notes	#REF!
#REF!	Track & Field	9	43	HAMMERS - Gloves - Hammer - Has extra wide leather piece over fingers for longer wear and safety - Left Large - TGLL	Stackhouse	TGLL	EACH	\$ 40.000	5.0%	\$ 2.000	\$ 38.000	+ shipping - see freight notes	#REF!

Bidding Company Name:				Partac Peat Corporation	Catalog Name:		9 - Running Tracks / Shot Put Sector Surfacing / Long Jump Pits						
No.	Product Category	Beam Clay Catalog Section #	Page#	Product Description	Manufacturer	Vendor SKU	Unit of Measure	Catalog List Price	Bid Discount Percentage	Discount Amt.	Net Effective Bid Price	Comments	No.
#REF!	Track & Field	9	43	HAMMERS - Gloves - Hammer - Has extra wide leather piece over fingers for longer wear and safety - Left X-Large - TGLXL	Stackhouse	TGLXL	EACH	\$ 40.000	5.0%	\$ 2.000	\$ 38.000	+ shipping - see freight notes	#REF!
#REF!	Track & Field	9	43	HAMMERS - Gloves - Hammer - Has extra wide leather piece over fingers for longer wear and safety - Right - Medium - TGRM	Stackhouse	TGRM	EACH	\$ 40.000	5.0%	\$ 2.000	\$ 38.000	+ shipping - see freight notes	#REF!
#REF!	Track & Field	9	43	HAMMERS - Gloves - Hammer - Has extra wide leather piece over fingers for longer wear and safety - Right - Large - TGRL	Stackhouse	TGRL	EACH	\$ 40.000	5.0%	\$ 2.000	\$ 38.000	+ shipping - see freight notes	#REF!
#REF!	Track & Field	9	43	HAMMERS - Gloves - Hammer - Has extra wide leather piece over fingers for longer wear and safety - Right -X-Large - TGRXL	Stackhouse	TGRXL	EACH	\$ 40.000	5.0%	\$ 2.000	\$ 38.000	+ shipping - see freight notes	#REF!
#REF!	Track & Field	9	43	HAMMERS - Cantabrian Aluminum Hammer Handle - TCAHH	Stackhouse	TCAHH	EACH	\$ 69.000	5.0%	\$ 3.450	\$ 65.550	+ shipping - see freight notes	#REF!
#REF!	Track & Field	9	43	HAMMERS - Hammer Handle - Olympic Straight Aluminum - THO	Stackhouse	THO	EACH	\$ 37.000	5.0%	\$ 1.850	\$ 35.150	+ shipping - see freight notes	#REF!
#REF!	Track & Field	9	43	HAMMERS - Hammer Handle - Olympic Curved Aluminum - THOCU	Stackhouse	THOCU	EACH	\$ 37.000	5.0%	\$ 1.850	\$ 35.150	+ shipping - see freight notes	#REF!
#REF!	Track & Field	9	43	HAMMERS - Hammer Handle - Competition Steel! - TSH	Stackhouse	TSH	EACH	\$ 21.000	5.0%	\$ 1.050	\$ 19.950	+ shipping - see freight notes	#REF!
#REF!	Track & Field	9	43	MULTI-USE IMPLEMENT CART - Heavy Duty, All Steel, Rides on 4 wheels - TMIC	Stackhouse	TMIC	EACH	\$ 749.000	5.0%	\$ 37.450	\$ 711.550	+ shipping - see freight notes	#REF!
#REF!	Track & Field	9	43	SHOT & DISCUS CARRY BAG - Canvas - TCCB	Stackhouse	TCCB	EACH	\$ 35.000	5.0%	\$ 1.750	\$ 33.250	+ shipping - see freight notes	#REF!
#REF!	Track & Field	9	43	SHOT & DISCUS CARRY BAG - Vinyl - TVCB	Stackhouse	TVCB	EACH	\$ 19.000	5.0%	\$ 0.950	\$ 18.050	+ shipping - see freight notes	#REF!
#REF!	Track & Field	9	43	SHOT & DISCUS CARRY BAG - Vinyl with Strap - TVCBS	Stackhouse	TVCBS	EACH	\$ 21.000	5.0%	\$ 1.050	\$ 19.950	+ shipping - see freight notes	#REF!
#REF!	Track & Field	9	43	SHOT CARRIER - TSPC	Stackhouse	TSPC	EACH	\$ 14.000	5.0%	\$ 0.700	\$ 13.300	+ shipping - see freight notes	#REF!
#REF!	Track & Field	9	43	Distance Markers - Dozen - TDM	Stackhouse	TDM	PACKAGE	\$ 40.000	5.0%	\$ 2.000	\$ 38.000	+ shipping - see freight notes	#REF!
#REF!	Track & Field	9	44	STANDS & MISCELLANEOUS ACCESSORIES - Track Starters Stand - TSSTAND	Stackhouse	TSSTAND	EACH	\$ 635.000	5.0%	\$ 31.750	\$ 603.250	+ shipping - see freight notes	#REF!
#REF!	Track & Field	9	44	STANDS & MISCELLANEOUS ACCESSORIES - Track Judge's Stand - TTJS	Stackhouse	TTJS	EACH	\$ 1,295.000	5.0%	\$ 64.750	\$ 1,230.250	+ shipping - see freight notes	#REF!
#REF!	Track & Field	9	44	STANDS & MISCELLANEOUS ACCESSORIES - Track Equipment Wagon - TSEW	Stackhouse	TSEW	EACH	\$ 269.000	5.0%	\$ 13.450	\$ 255.550	+ shipping - see freight notes	#REF!
#REF!	Track & Field	9	44	STANDS & MISCELLANEOUS ACCESSORIES - Pit Rake - 24" - TGR24	Stackhouse	TGR24	EACH	\$ 69.000	5.0%	\$ 3.450	\$ 65.550	+ shipping - see freight notes	#REF!
#REF!	Track & Field	9	44	STANDS & MISCELLANEOUS ACCESSORIES - Infield Rake - 36" - TGR	Stackhouse	TGR	EACH	\$ 80.000	5.0%	\$ 4.000	\$ 76.000	+ shipping - see freight notes	#REF!
#REF!	Track & Field	9	44	STANDS & MISCELLANEOUS ACCESSORIES - Plastic Flag Ropes -100' length, Stock Color Red White and Blue - FPPR	Stackhouse	FPPR	EACH	\$ 32.000	5.0%	\$ 1.600	\$ 30.400	+ shipping - see freight notes	#REF!
#REF!	Track & Field	9	44	STANDS & MISCELLANEOUS ACCESSORIES - Boundry Cones - Heavy Duty with weighted bases - 12" - FBC12	Stackhouse	FBC12	EACH	\$ 18.000	5.0%	\$ 0.900	\$ 17.100	+ shipping - see freight notes	#REF!
#REF!	Track & Field	9	44	STANDS & MISCELLANEOUS ACCESSORIES - Boundry Cones - Heavy Duty with weighted bases - 18" - FBC18	Stackhouse	FCB18	EACH	\$ 19.000	5.0%	\$ 0.950	\$ 18.050	+ shipping - see freight notes	#REF!
#REF!	Track & Field	9	45	OFFICIATING & MISCELLANEOUS ACCESSORIES - Lap Counter with Bell - TLC	Stackhouse	TLC	EACH	\$ 455.000	5.0%	\$ 22.750	\$ 432.250	+ shipping - see freight notes	#REF!
#REF!	Track & Field	9	45	OFFICIATING & MISCELLANEOUS ACCESSORIES - Performance Indicators - 4 Digit - TEPI-4	Stackhouse	TEPI-4	EACH	\$ 565.000	5.0%	\$ 28.250	\$ 536.750	+ shipping - see freight notes	#REF!
#REF!	Track & Field	9	45	OFFICIATING & MISCELLANEOUS ACCESSORIES - Performance Indicators - 5 Digit - TEPI-5	Stackhouse	TEPI-5	EACH	\$ 595.000	5.0%	\$ 29.750	\$ 565.250	+ shipping - see freight notes	#REF!

Bidding Company Name:				Partac Peat Corporation	Catalog Name:		9 - Running Tracks / Shot Put Sector Surfacing / Long Jump Pits						
No.	Product Category	Beam Clay Catalog Section #	Page#	Product Description	Manufacturer	Vendor SKU	Unit of Measure	Catalog List Price	Bid Discount Percentage	Discount Amt.	Net Effective Bid Price	Comments	No.
#REF!	Track & Field	9	45	OFFICIATING & MISCELLANEOUS ACCESSORIES - Replacement Digital Numbers - Black - TDI	Stackhouse	TDI	EACH	\$ 98.000	5.0%	\$ 4.900	\$ 93.100	+ shipping - see freight notes	#REF!
#REF!	Track & Field	9	45	OFFICIATING & MISCELLANEOUS ACCESSORIES - Replacement Digital Numbers - Red - TDIR	Stackhouse	TDIR	EACH	\$ 98.000	5.0%	\$ 4.900	\$ 93.100	+ shipping - see freight notes	#REF!
#REF!	Track & Field	9	45	OFFICIATING & MISCELLANEOUS ACCESSORIES - Wind Gauge - TWG	Stackhouse	TWG	EACH	\$ 439.000	5.0%	\$ 21.950	\$ 417.050	+ shipping - see freight notes	#REF!
#REF!	Track & Field	9	45	OFFICIATING & MISCELLANEOUS ACCESSORIES - Track and Field Score Book - TSB	Stackhouse	TSB	EACH	\$ 15.000	5.0%	\$ 0.750	\$ 14.250	+ shipping - see freight notes	#REF!
#REF!	Track & Field	9	45	OFFICIATING & MISCELLANEOUS ACCESSORIES - Digital Implement Scale - TDIS	Stackhouse	TDIS	EACH	\$ 132.000	5.0%	\$ 6.600	\$ 125.400	+ shipping - see freight notes	#REF!
#REF!	Track & Field	9	45	OFFICIATING & MISCELLANEOUS ACCESSORIES - Ultrak Scoreboard/Display - TSWSCORE	Stackhouse	TSWSCORE	EACH	\$ 875.000	5.0%	\$ 43.750	\$ 831.250	+ shipping - see freight notes	#REF!
#REF!	Track & Field	9	45	OFFICIATING & MISCELLANEOUS ACCESSORIES - Ultrak T-100 Display/Race Clock - TSWT100	Stackhouse	TSWT100	EACH	\$ 659.000	5.0%	\$ 32.950	\$ 626.050	+ shipping - see freight notes	#REF!
#REF!	Track & Field	9	46	CANTABRIAN ALUMINUM DISCUS CAGE - Sector Line Tape with Reel	Stackhouse	SLT	EACH	\$ 265.000	5.0%	\$ 13.250	\$ 251.750	+ shipping - see freight notes	#REF!
#REF!	Track & Field	9	46	DISCUS CAGE & RINGS - Cantabrian Aluminum Discus Cage - High School - THCSA-14	Stackhouse	THCSA-14	EACH	\$ 2,775.000	5.0%	\$ 138.750	\$ 2,636.250	+ shipping - see freight notes	#REF!
#REF!	Track & Field	9	46	DISCUS CAGE & RINGS - Cantabrian Aluminum Discus Cage - High School - Replacement Net - THCSA14x58	Stackhouse	THCSA14x58	EACH	\$ 1,365.000	5.0%	\$ 68.250	\$ 1,296.750	+ shipping - see freight notes	#REF!
#REF!	Track & Field	9	46	DISCUS CAGE & RINGS - Cantabrian Aluminum Discus Cage - High School - Replacement Sleeve - THCSASL	Stackhouse	THCSASL	EACH	\$ 55.000	5.0%	\$ 2.750	\$ 52.250	+ shipping - see freight notes	#REF!
#REF!	Track & Field	9	46	DISCUS CAGE & RINGS - Cantabrian - 13'4" Height with 6 square steel, white powder coated poles - THSCAN14	Stackhouse	THSCAN14	EACH	\$ 2,815.000	5.0%	\$ 140.750	\$ 2,674.250	+ shipping - see freight notes	#REF!
#REF!	Track & Field	9	46	DISCUS CAGE & RINGS - Cantabrian - 13'4" Height with 6 square steel, white powder coated poles - Replacement Net for THSCAN14 - TDC14X55RPL	Stackhouse	TDC14X55RPL	EACH	\$ 855.000	5.0%	\$ 42.750	\$ 812.250	+ shipping - see freight notes	#REF!
#REF!	Track & Field	9	46	DISCUS CAGE & RINGS - Cantabrian - 13'4" Height with 6 square steel, white powder coated poles - Replacement Sleeve for THSCAN14 - THSCAN14SL	Stackhouse	THSCAN14SL	EACH	\$ 50.000	5.0%	\$ 2.500	\$ 47.500	+ shipping - see freight notes	#REF!
#REF!	Track & Field	9	46	DISCUS CAGE & RINGS - Webbed Discus Ring - TCDWEB	Stackhouse	TCDWEB	EACH	\$ 789.000	5.0%	\$ 39.450	\$ 749.550	+ shipping - see freight notes	#REF!
#REF!	Track & Field	9	46	DISCUS CAGE & RINGS - Webbed Shot/Hammer Ring - TCSHWEB	Stackhouse	TCSHWEB	EACH	\$ 765.000	5.0%	\$ 38.250	\$ 726.750	+ shipping - see freight notes	#REF!
#REF!	Track & Field	9	46	DISCUS CAGE & RINGS - Official Circles - 4 piece Discus Ring - TADR	Stackhouse	TADR	EACH	\$ 230.000	5.0%	\$ 11.500	\$ 218.500	+ shipping - see freight notes	#REF!
#REF!	Track & Field	9	46	DISCUS CAGE & RINGS - Official Circles - 4 piece Shot Ring - TASR	Stackhouse	TASR	EACH	\$ 230.000	5.0%	\$ 11.500	\$ 218.500	+ shipping - see freight notes	#REF!
#REF!	Track & Field	9	46	DISCUS CAGE & RINGS - Official Circles - 2 piece Discus Ring - T2PCD	Stackhouse	T2PCD	EACH	\$ 295.000	5.0%	\$ 14.750	\$ 280.250	+ shipping - see freight notes	#REF!
#REF!	Track & Field	9	46	DISCUS CAGE & RINGS - Official Circles - 2 piece Shot Ring - T2PCS	Stackhouse	T2PCS	EACH	\$ 259.000	5.0%	\$ 12.950	\$ 246.050	+ shipping - see freight notes	#REF!
#REF!	Track & Field	9	46	DISCUS CAGE & RINGS - Sector Guide - TSG	Stackhouse	TSG	EACH	\$ 102.000	5.0%	\$ 5.100	\$ 96.900	+ shipping - see freight notes	#REF!
#REF!	Track & Field	9	46	DISCUS CAGE & RINGS - Sector Line Marking Tape - White - TSTW	Stackhouse	TSTW	EACH	\$ 49.000	5.0%	\$ 2.450	\$ 46.550	+ shipping - see freight notes	#REF!
#REF!	Track & Field	9	46	DISCUS CAGE & RINGS - Sector Line Marking Tape - Orange - TSTO	Stackhouse	TSTO	EACH	\$ 49.000	5.0%	\$ 2.450	\$ 46.550	+ shipping - see freight notes	#REF!
#REF!	Track & Field	9	46	DISCUS CAGE & RINGS - Spool for Sector Tape - TSTS	Stackhouse	TSTS	EACH	\$ 27.000	5.0%	\$ 1.350	\$ 25.650	+ shipping - see freight notes	#REF!
#REF!	Track & Field	9	46	DISCUS CAGE & RINGS - Ground Staples for Tape, Pack of 10	Stackhouse	TGS	PACK	\$ 18.000	5.0%	\$ 0.900	\$ 17.100	+ shipping - see freight notes	#REF!

Bidding Company Name:				Partac Peat Corporation		Catalog Name:		9 - Running Tracks / Shot Put Sector Surfacing / Long Jump Pits					
No.	Product Category	Beam Clay Catalog Section #	Page#	Product Description	Manufacturer	Vendor SKU	Unit of Measure	Catalog List Price	Bid Discount Percentage	Discount Amt.	Net Effective Bid Price	Comments	No.
#REF!	Track & Field	9	47	HIGH SCHOOL PORTABLE DISCUS CAGE #HSDC-P	AAE	HSDC-P	EACH	\$ 13,775.000	5.0%	\$ 688.750	\$ 13,086.250	+ shipping - see freight notes	#REF!
#REF!	Track & Field	9	47	COLLEGIATE PORTABLE DISCUS CAGE #CDC-P	AAE	CDC-P	EACH	\$ 18,895.000	5.0%	\$ 944.750	\$ 17,950.250	+ shipping - see freight notes	#REF!
#REF!	Track & Field	9	47	PREMIER OUTDOOR THROWING PLATFORM #POP	AAE	POP	EACH	\$ 8,495.000	5.0%	\$ 424.750	\$ 8,070.250	+ shipping - see freight notes	#REF!
#REF!	Track & Field	9	47	VINYL SANDBAGS #VSZ	AAE	VSZ	EACH	\$ 75.000	5.0%	\$ 3.750	\$ 71.250	+ shipping - see freight notes	#REF!
#REF!	Track & Field	9	47	BASE WEIGHT #BW-80	AAE	BW-80	EACH	\$ 625.000	5.0%	\$ 31.250	\$ 593.750	+ shipping - see freight notes	#REF!
#REF!	Track & Field	9	various	CUTTING CHARGE - #CPTCUT	Grasstex	CPTCUT	EACH	\$ 50.000	5.0%	\$ 2.500	\$ 47.500	+ shipping - see freight notes	#REF!
#REF!	Track & Field	9	various	TRIMMING CHARGE - #CPTTRIM	Grasstex	CPTTRIM	EACH	\$ 50.000	5.0%	\$ 2.500	\$ 47.500	+ shipping - see freight notes	#REF!